

# PERI Rental Criteria

## HDS Basic Components

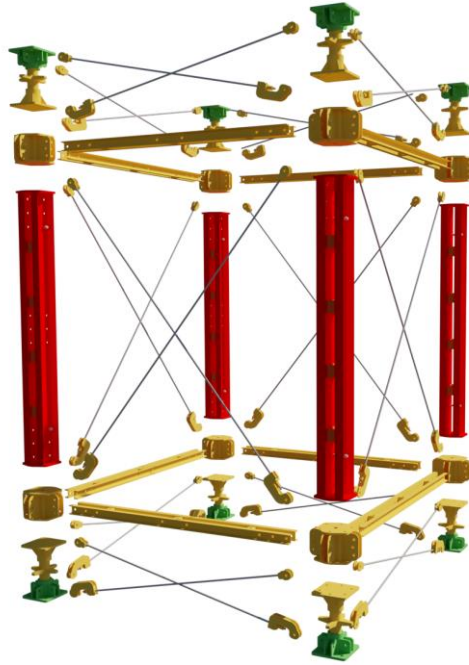

**PERI (Hong Kong) Limited**  
 19C&D, Tower B, Billion Centre  
 1 Wang Kwong Road  
 Kowloon Bay  
 Hong Kong  
 Phone: +852 3102 7900  
 Fax: +852 3188 9258  
[info@perihk.com](mailto:info@perihk.com)















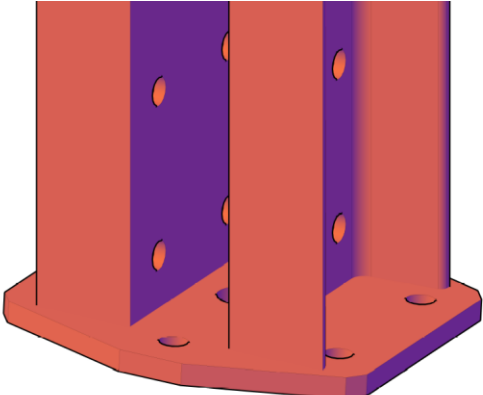

Content	Page
HDS STANDARD 1000/1500/2000/2500/4000	2
HDS CONNECTOR	7
HDS LEDGER 1500/2000/2500/3000/3500/4000/4500	8
HDS STANDARD 110/200	13
HDS LEDGER 500	13
HDS SCREW JACK	14
HDS WEB CONNECTOR	16
HDS FLANGE CONNECOR	16
HDS BRACING NUT	17
HDS BRACING HOOK	18

Changes made	Date   Initial	Page
New version	31.05.22   SR	

# PERI Rental Criteria

## HDS Basic Components



HDS STANDARD 1000/1500/2000/2500/4000	Description	Instruction	Billing Instruction	Type
	<p><b>61.10.01.01</b> Dents in profile</p> <ul style="list-style-type: none"> <li>If possible</li> <li>If not possible</li> </ul>	<p>If possible: </p> <p>If not possible:  </p>	<p>088244</p> <p></p> <p></p>	<p></p> <p></p>
	<p><b>61.10.01.02</b> End-plate bent (not perpendicular to the profile)</p> <p><b>61.10.01.03</b> Cracks in welding</p>	<p> </p> <p> </p>	<p></p> <p></p>	<p></p> <p></p>

# PERI Rental Criteria

## HDS Basic Components



HDS STANDARD 1000/1500/2000/2500/4000	Description	Instruction	Billing Instruction	Type
---------------------------------------	-------------	-------------	---------------------	------

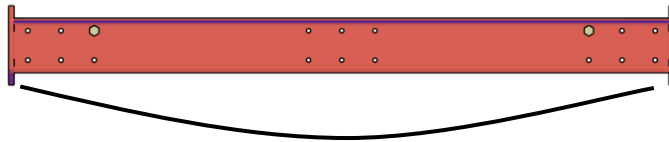

### 61.10.01.04 Bent at web direction

- $\leq$  permitted bent ( $L/500$ )
- $>$  permitted bent ( $L/500$ )



Component	Perm. bending
HDS STANDARD 1000	2 mm
HDS STANDARD 1500	4 mm
HDS STANDARD 2000	5 mm
HDS STANDARD 2500	6 mm
HDS STANDARD 4000	8 mm

# PERI Rental Criteria

## HDS Basic Components



HDS STANDARD 1000/1500/2000/2500/4000	Description	Instruction	Billing Instruction	Type
---------------------------------------	-------------	-------------	---------------------	------

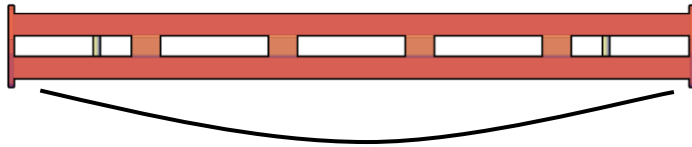

### 61.10.01.05 Bent at cross direction

- $\leq$  permitted bent ( $L/500$ )
- $>$  permitted bent ( $L/500$ )



Component	Perm. bending
HDS STANDARD 1000	2 mm
HDS STANDARD 1500	4 mm
HDS STANDARD 2000	5 mm
HDS STANDARD 2500	6 mm
HDS STANDARD 4000	8 mm

# PERI Rental Criteria

## HDS Basic Components



HDS STANDARD 1000/1500/2000/2500/4000	Description	Instruction	Billing Instruction	Type
---------------------------------------	-------------	-------------	---------------------	------

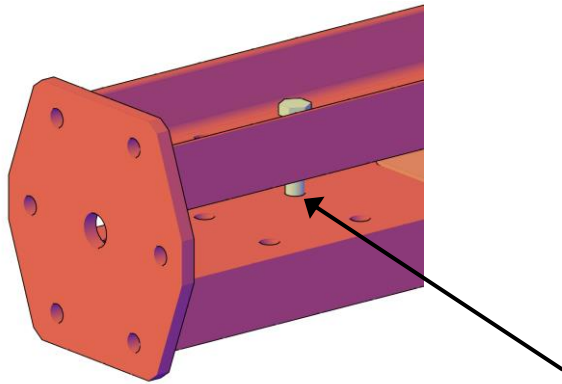

61.10.01.06 Bolt missing



200055  
200035











61.10.01.07 Drill holes

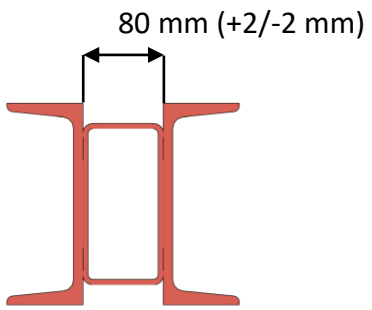

# PERI Rental Criteria

## HDS Basic Components











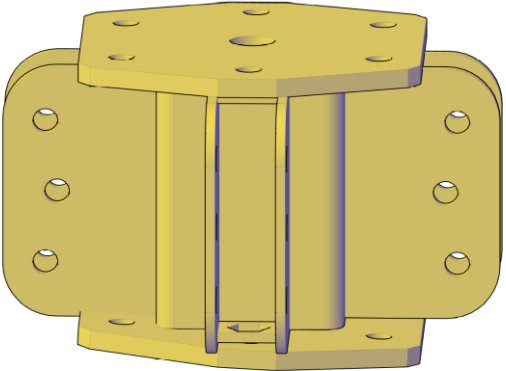

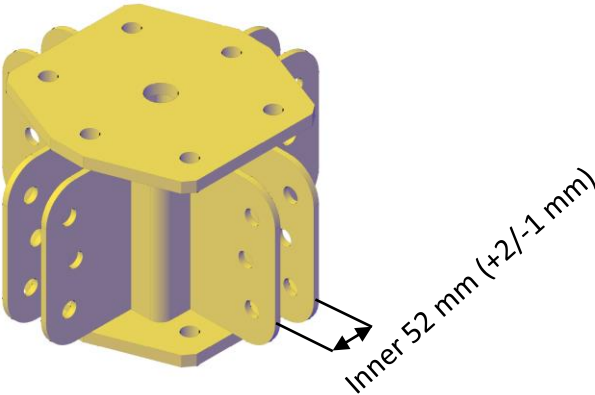

HDS STANDARD 1000/1500/2000/2500/4000	Description	Instruction	Billing Instruction	Type
	<p><b>61.10.01.08</b> Distance between the profiles beyond tolerances</p>			
	<p><b>61.10.01.09</b> Cut in</p>			

# PERI Rental Criteria

## HDS Basic Components











HDS CONNECTOR	Description	Instruction	Billing Instruction	Type
	<p><b>61.10.02.01</b> End-plate bent (not perpendicular to the profile)</p>			
	<p><b>61.10.02.02</b> Cracks in welding</p>			
	<p><b>61.10.02.03</b> Distance between the plates beyond tolerances</p> <ul style="list-style-type: none"> <li>▪ If possible</li> <li>▪ If not possible</li> </ul>	 	<p>088244</p>  	 

# PERI Rental Criteria

## HDS Basic Components



HDS LEDGER 1500-4500	Description	Instruction	Billing Instruction	Type
	61.10.03.01 Cut off			
	61.10.03.02 Cut in			



# PERI Rental Criteria

## HDS Basic Components



HDS LEDGER 1500-4500	Description	Instruction	Billing Instruction	Type
----------------------	-------------	-------------	---------------------	------

**61.10.03.03** Bent at web direction

- $\leq$  permitted bent (L/500)
- $>$  permitted bent (L/500)

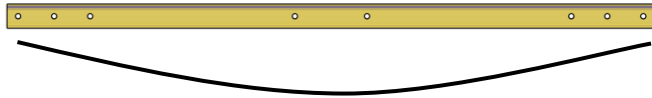

Component	Perm. bending
HDS LEDGER 1500	3 mm
HDS LEDGER 2000	4 mm
HDS LEDGER 2500	5 mm
HDS LEDGER 3000	6 mm
HDS LEDGER 3500	7 mm
HDS LEDGER 4000	8 mm
HDS LEDGER 4500	9 mm

# PERI Rental Criteria

## HDS Basic Components



HDS LEDGER 1500-4500	Description	Instruction	Billing Instruction	Type
----------------------	-------------	-------------	---------------------	------

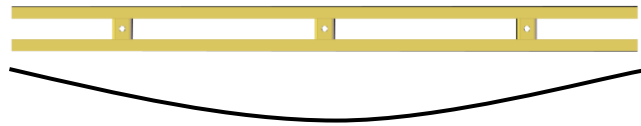

### 61.10.03.04 Bent at cross direction

- $\leq$  permitted bent ( $L/500$ )
- $>$  permitted bent ( $L/500$ )



Component	Perm. bending
HDS LEDGER 1500	3 mm
HDS LEDGER 2000	4 mm
HDS LEDGER 2500	5 mm
HDS LEDGER 3000	6 mm
HDS LEDGER 3500	7 mm
HDS LEDGER 4000	8 mm
HDS LEDGER 4500	9 mm

# PERI Rental Criteria

## HDS Basic Components



HDS LEDGER 1500-4500	Description	Instruction	Billing Instruction	Type
----------------------	-------------	-------------	---------------------	------

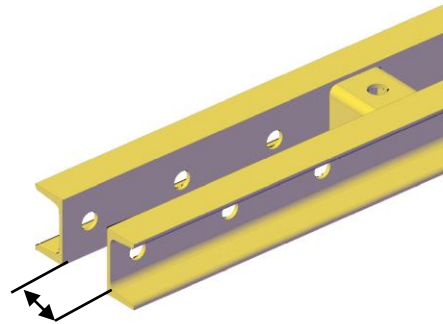

Inner 72 mm (+2/-2 mm)

**61.10.03.05** Distance between the profiles beyond tolerances

- If possible
- If not possible



088244















**61.10.03.06** Drill holes



# PERI Rental Criteria

## HDS Basic Components











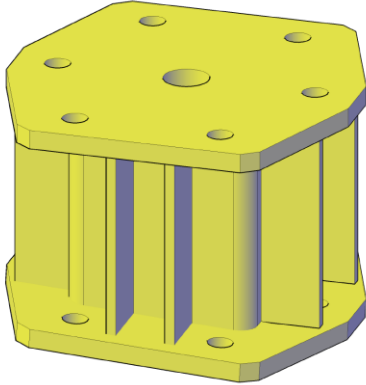



HDS LEDGER 1500-4500	Description	Instruction	Billing Instruction	Type
	<b>61.10.03.07</b> Profile end bent		088244	
	<ul style="list-style-type: none"> <li>▪ If possible</li> </ul>			
	<b>61.10.03.08</b> Dent in profile		088244	
	<ul style="list-style-type: none"> <li>▪ If not possible</li> </ul>	  		
		  		

# PERI Rental Criteria

## HDS Basic Components

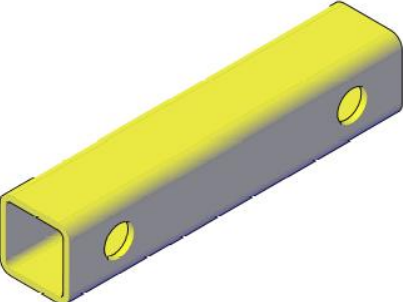









HDS STANDARD 110/200	Description	Instruction	Billing Instruction	Type
	61.10.04.01 End-plate bent (not perpendicular to the profile)	 		
	61.10.04.02 Cracks in welding	 		

HDS LEDGER 500	Description	Instruction	Billing Instruction	Type
	61.10.05.01 Tube dent / kink / junk	 		

# PERI Rental Criteria

## HDS Basic Components





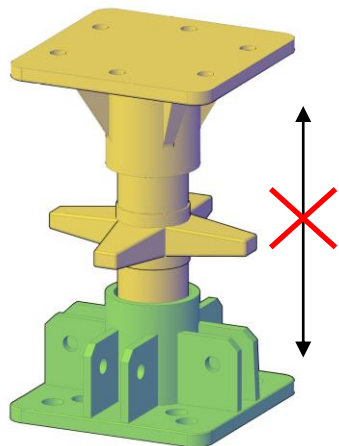



HDS SCREW JACK	Description	Instruction	Billing Instruction	Type
	<b>61.10.06.01 Thread</b> <ul style="list-style-type: none"> <li>▪ Heavily soiled</li> </ul>			
	<ul style="list-style-type: none"> <li>▪ Damaged</li> </ul>	 		



### 61.10.06.02 Spindle not movable

- If possible
- If not possible

		
 		

# PERI Rental Criteria

## HDS Basic Components



HDS SCREW JACK	Description	Instruction	Billing Instruction	Type
----------------	-------------	-------------	---------------------	------

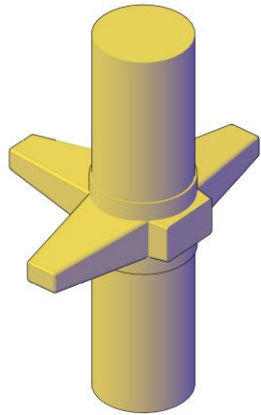

61.10.06.03 Claw is damaged/missing

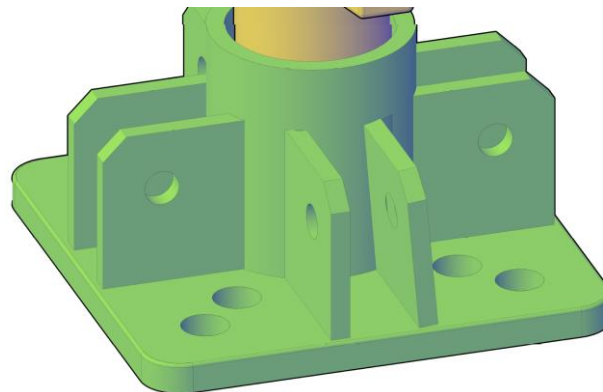

61.10.06.04 Connection plates bent

- If possible
- If not possible













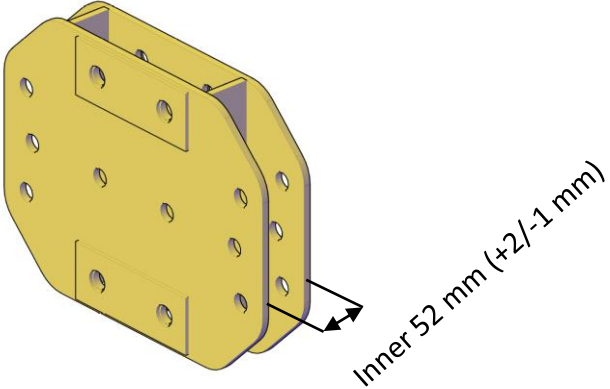





088244

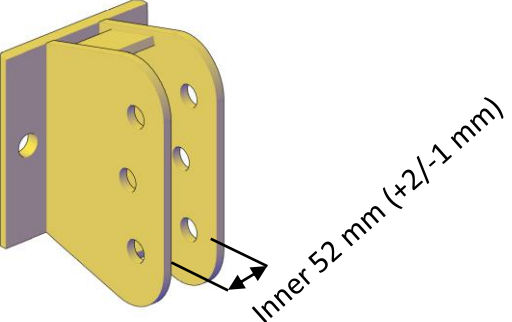

# PERI Rental Criteria

## HDS Basic Components













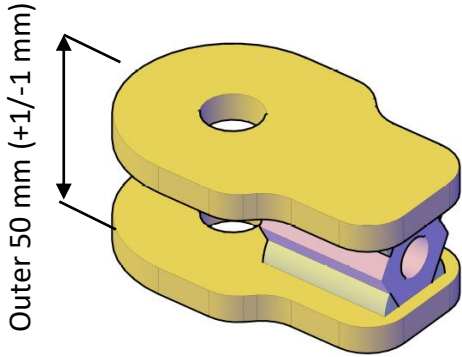



HDS WEB CONNECTOR	Description	Instruction	Billing Instruction	Type
	<p><b>61.10.07.01</b> Distance between the plates beyond tolerances</p> <ul style="list-style-type: none"> <li>▪ If possible</li> <li>▪ If not possible</li> </ul>	<p>     </p>	<p>088244</p> <p>    </p>	<p>    </p>
HDS FLANGE CONNECTOR	Description	Instruction	Billing Instruction	Type
	<p><b>61.10.08.01</b> Connection plates bent</p> <ul style="list-style-type: none"> <li>▪ If possible</li> <li>▪ If not possible</li> </ul>	<p>     </p>	<p>088244</p> <p>    </p>	<p>    </p>



# PERI Rental Criteria

## HDS Basic Components









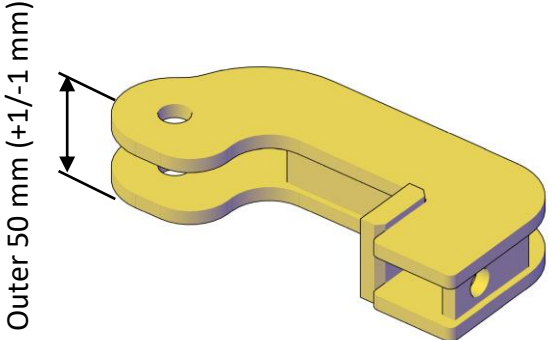

HDS BRACING NUT	Description	Instruction	Billing Instruction	Type
	<p><b>61.10.09.01</b> Distance between the plates beyond tolerances</p> <ul style="list-style-type: none"> <li>▪ If possible</li> <li>▪ If not possible</li> </ul>	<p>     </p>	<p>088244</p> <p>    </p>	<p>    </p>
	<p><b>61.10.09.02</b> Heavily soiled thread</p> <ul style="list-style-type: none"> <li>▪ If possible</li> <li>▪ If not possible</li> </ul>	<p>     </p>	<p>    </p>	<p>    </p>

# PERI Rental Criteria

## HDS Basic Components



















HDS BRACING HOOK	Description	Instruction	Billing Instruction	Type
 <p>Outer 50 mm (+1/-1 mm)</p>	<p><b>61.10.10.01</b> Distance between the plates beyond tolerances</p> <ul style="list-style-type: none"> <li>▪ If possible</li> <li>▪ If not possible</li> </ul>	  	<p>088244</p>  	 

# PERI Rental Criteria

## Glossary icons



Icon	Significance	Icon	Significance	Icon	Significance
	Not Ok– material is scrap		Billing necessary (customer)		Optical damage
	OK– material stays in rental park		No Billing necessary		Functional damage
	Scrap material– it's not permitted to hand out the material because of safety aspects		Shorten the material		Functional damage— it's <b>not</b> permitted to hand out the material
	Repair according to instruction		Mark the material		Static damage— it's <b>not</b> permitted to hand out the material
	Fix material cold – Afterwards, check weld seams and bordering components		Replace damaged material		
	Repair after local economic efficiency calculation		Replace missing material		
	Clean the material				