

Climbing Systems CB 240 and CB 160
Safe working conditions with
wall formwork at all heights



Edition 04 | 2014

PERI GmbH
Formwork Scaffolding Engineering

Rudolf-Diesel-Strasse 19
89264 Weissenhorn
Germany
Tel. +49 (0) 7309.950-0
Fax +49 (0) 7309.951-0
info@peri.com
www.peri.com

Important Notes:

Without exception, all current safety regulations must be observed in those countries where our products are used.

The photos shown in this brochure feature construction sites in progress. For this reason especially safety and anchor details cannot always be considered as conclusive or final. These are subject to the risk assessment carried out by the contractor.

The systems or items shown are not necessarily available in all countries.

Safety instructions and load specifications are to be strictly observed at all times. Separate structural calculations are required for any deviations from the standard design data.

The information contained herein is subject to technical changes in the interests of progress. Errors and typographical mistakes reserved.

Content

Climbing Systems CB 240 and CB 160

- 2 Safety at all heights
- 4 For all heights and every ground plan
- 6 With VARIO GT 24, MAXIMO, TRIO or RUNDFLEX
- 8 Construction-compliant load assumptions,
simple formwork adjustment
- 10 Wind loads, large VARIO standard elements
- 12 Even platform planking, Formwork Carriage CB 240
- 14 CB 240 climbing cycle sequence
- 16 Application and moving procedure of CB 160
- 18 Certified scaffolding anchoring
- 20 High level of working safety with system components

BR shaft platforms

- 22 Safe support for inside shaft formwork
- 24 Components

Climbing System CB

Safety at all heights

CB climbing scaffold systems provide high levels of safety in all areas of application.

With the CB 240, the formwork is mounted on a carriage with roller bearings and can be moved by approx. 75 cm. This results in sufficient space being created for cleaning the formlining as well as for reinforcement work. The 2.40 m wide platform planking is flush with the Carriage CB and free of any tripping hazards.

With the CB 160, the formwork is simply tipped backwards for striking. With both systems, the formwork is moved to the next pour together with the scaffold in one crane lift.



Photo on the right
Bridge pier
Architectural concrete
with CB 240 and
VARIO GT 24.

Cultural Buildings
High-quality architectural
concrete with CB 240
brackets and VARIO GT 24.



Apartments
CB 240 and CB 160 scaffold
brackets with VARIO GT 24.



Climbing System CB

For all heights and every ground plan

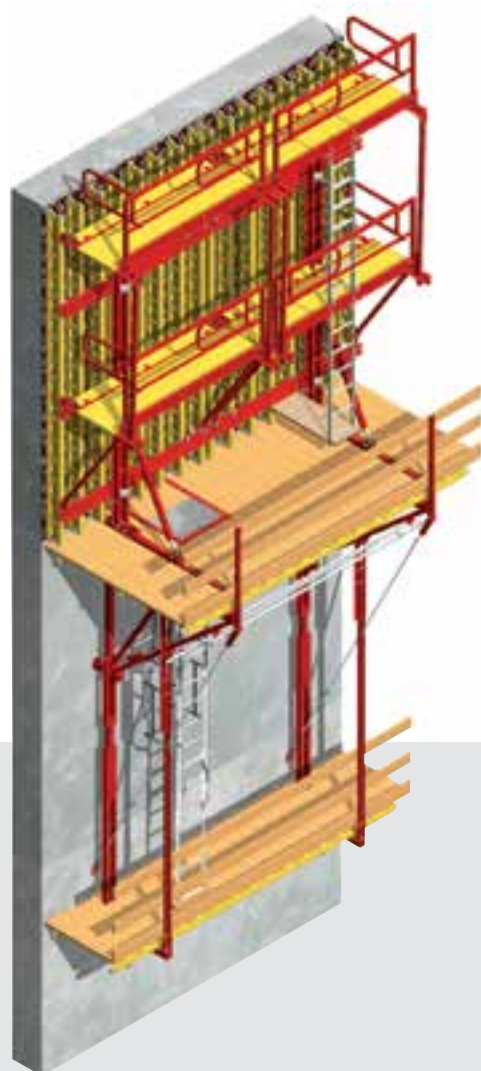

Hotel construction

CB 240 scaffold brackets complete with finishing platform and TRIO.

30-storey apartment building

CB 240 and CB 160 scaffold brackets with VARIO GT 24.

CB 240

Safe working areas and access with system components on the formwork and CB climbing scaffold.



LNG liquid gas tanks
Circular walls Ø 77.50 m with
CB 240 and VARIO GT 24.

Bridge pier
Architectural concrete with
CB 240 and VARIO GT 24.



Administration building
CB 240 with TRIO and
VARIO GT 24.



Safety
PERI ladder for safe access
to the finishing platform.





Administration building
 CB 240 with finishing platform and TRIO.

Airport control tower
 46 m high, external Ø 6.85 m.
 With PERI RUNDFLEX and
 CB 240 brackets.

Climbing System CB

Construction-compliant load assumptions, simple formwork adjustment

Construction-compliant load assumptions

The high loading capacity of the CB climbing system allows wide spans resulting in large scaffold units with high load assumptions.

On the PERI CB 240, for example, reinforcing bars can therefore be stored when the formwork is retracted.



CB 240
Formwork carriage in working position Formwork carriage in concreting position

CB 160

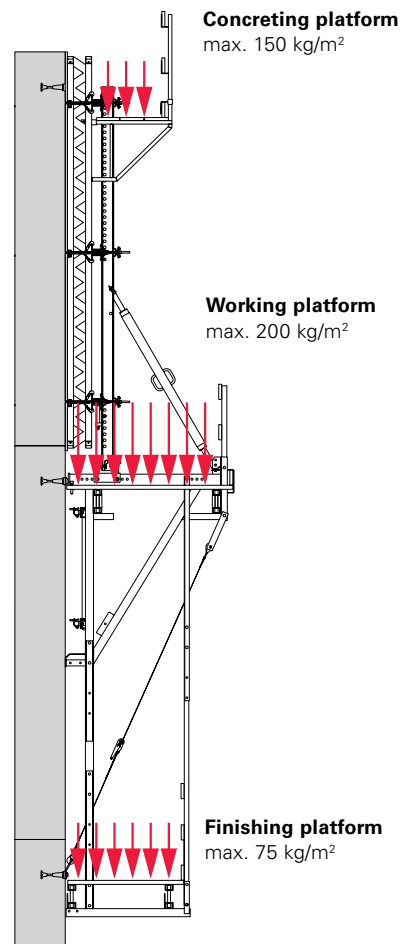
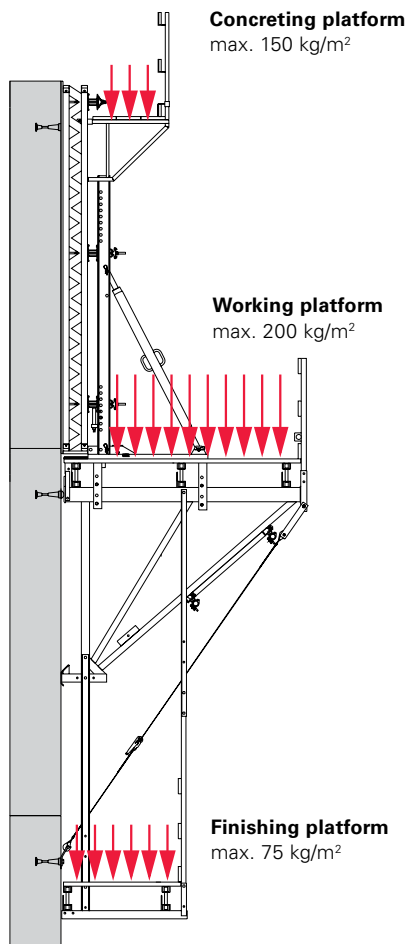
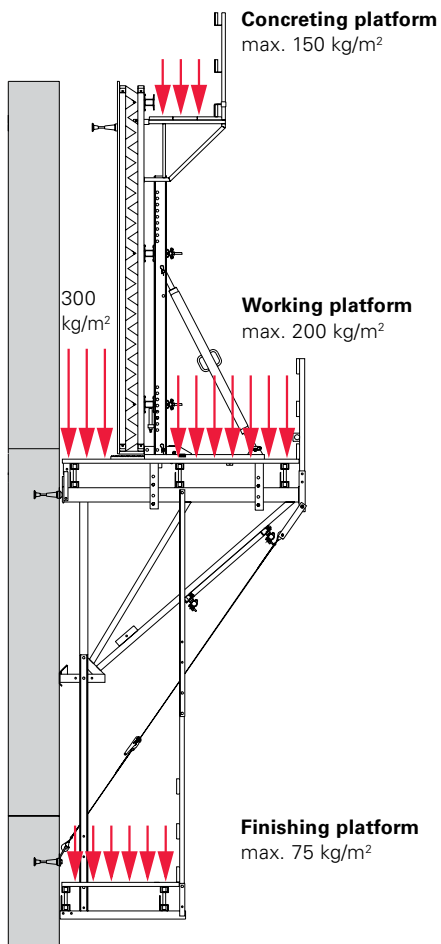

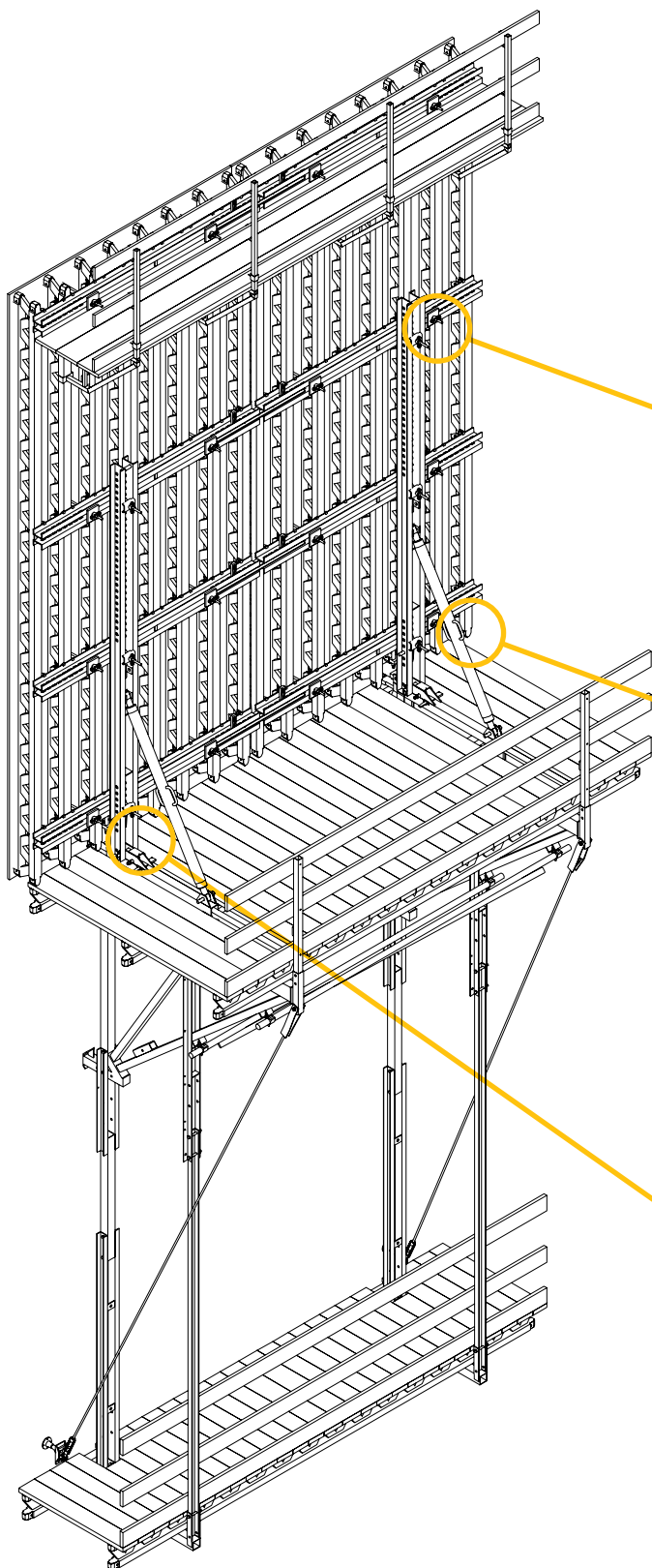

Simple adjustment of the formwork elements for neat and tidy concrete joints



Move element sideways
By releasing the Strongback Connector U 100-120.



Precise adjustment of the angle of inclination
With Adjustable Brace CB 164-224.

Element height adjustment
For VARIO GT 24.
With Height Adjusting Unit CB.

For MAXIMO and TRIO.
With Adapter TRIO-CB.



Climbing System CB

Wind loads, large VARIO standard elements

Wind loads

CB 240 and CB 160 design charts are available on request from PERI.

The PERI CB 240 provides wind safety at any position which means:

Locking the formwork on the carriage takes place quickly and securely by means of a wedge.

Complete safety against the wind immediately after mounting the tie rod.



CB 240 with VARIO GT 24 for construction of bridge piers.

Wind forces increase accordingly with the height. The DIN 1055, which forms the basis for the design, determines the wind loads according to wind zones, ground profiles and operating heights.

Wind dynamic pressure for transition zone inland and with load reduction factor* for period of application < 24 months.
*K = 0,7

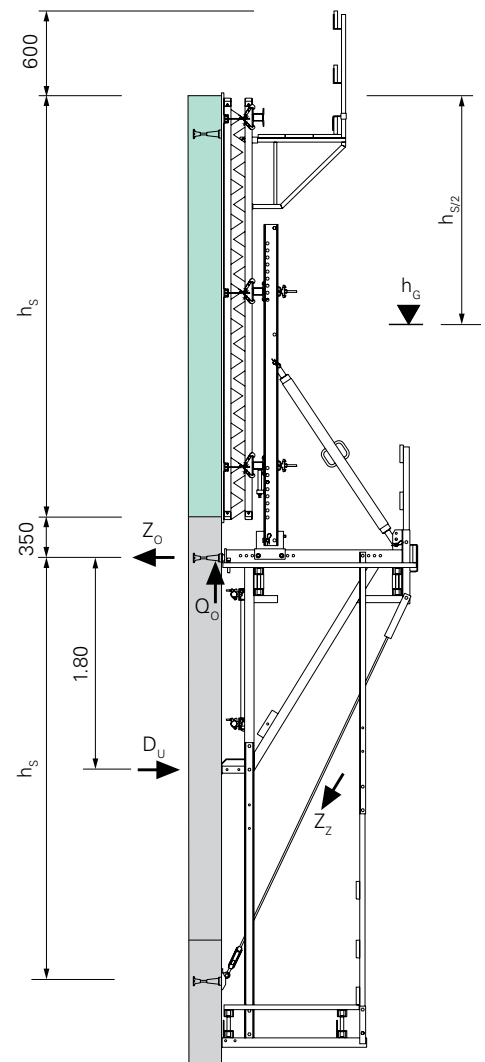
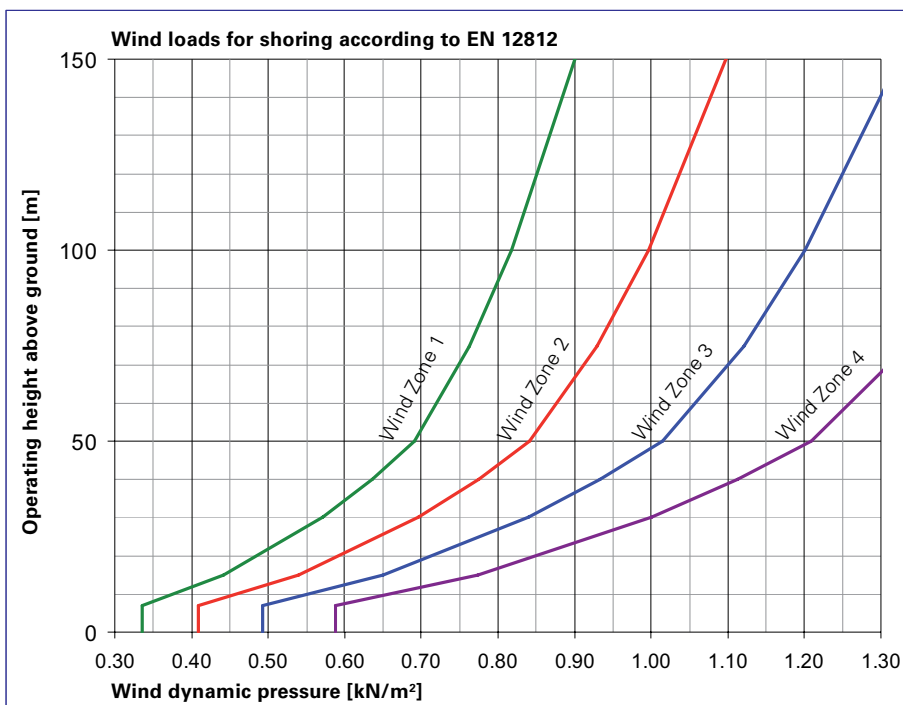

Large VARIO standard elements

The strong CB 240 and CB 160 scaffold brackets allow the application of large VARIO standard elements.

5.40 m x 5.00 m = 27 m² formwork surface area is possible on only 2 scaffold brackets also with wind speeds of more than 120 km/h with standard arrangement of the brackets.

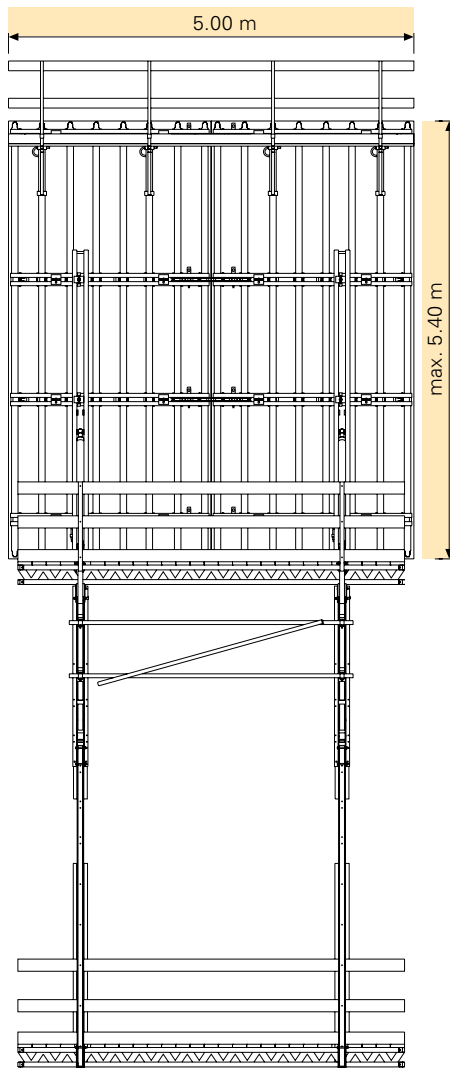

Extremely long platforms are also no problem with the CB 240 and CB 160.

Instead of timbers, GT 24 girders with high load capacity can be used as platform main beams. With a double GT 24 girder arrangement, platform lengths of up to maximum 10.50 m are possible.

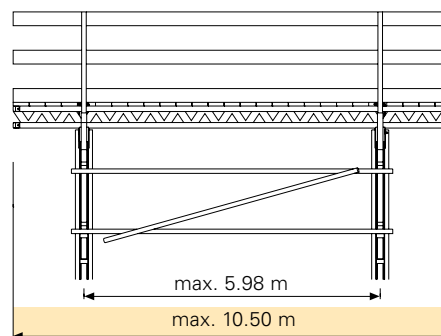

CB 240 with finishing platform and VARIO GT 24 for construction of LNG gas tanks.

Climbing System CB

Even platform planking, Formwork Carriage CB 240

Even platform planking

The 2.40 m wide planking has no tripping hazards and allows easy and safe movement on the working platform – in front of and behind the formwork.

With the PERI CB 240, the planking is positioned above the brackets. All possible tripping hazards are below the working platform.

The working platform can be transported pre-assembled thus saving space and connected with the CB 240 brackets on the construction site.



Safe working conditions on the CB 240 in protection of the formwork element.



Closed platform decking for safe working.



Safe and secure movement on the CB 240 working platform.

Carriage CB 240

With roller bearings for easy shuttering and striking.

This means that large formwork elements can also be easily moved forwards and backwards.

75 cm working area when the formwork is retracted

This creates sufficient space for cleaning the formlining as well as installing the reinforcement.

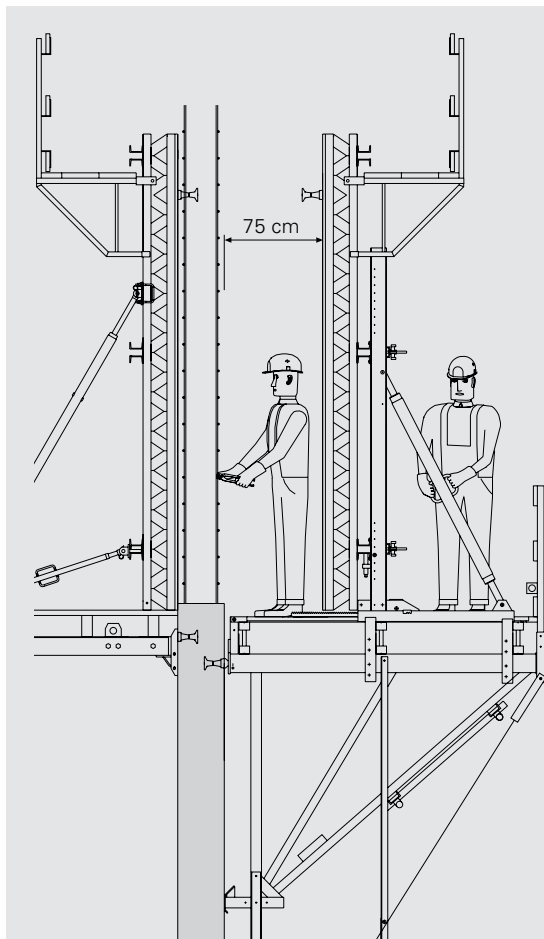
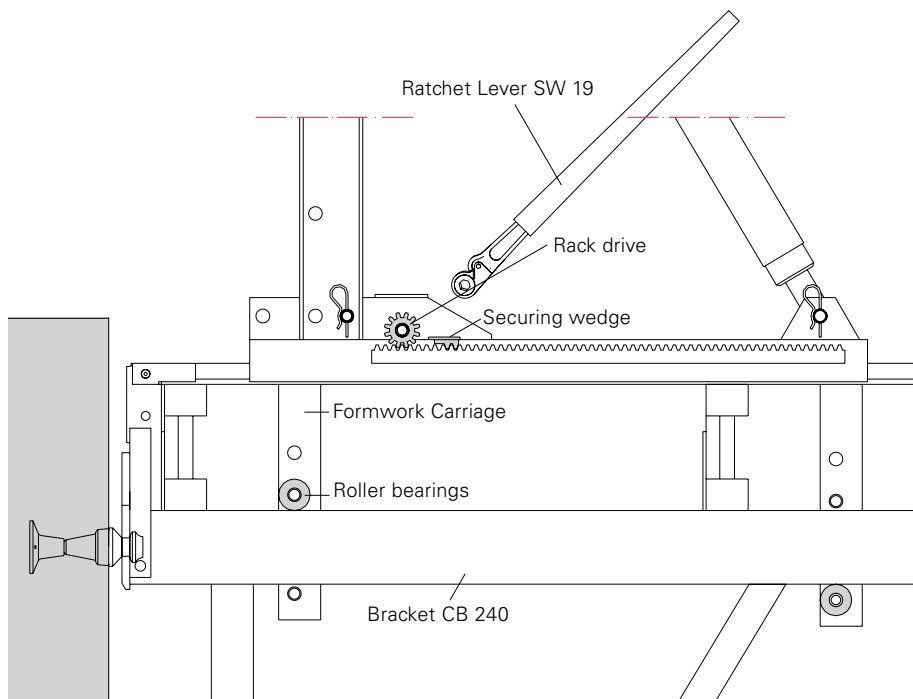

With the captive wedge, the carriage can be fixed in any moving position.

The Carriage CB 240 is moved using the Ratchet Lever SW 19, Item no. 027180.



Climbing System CB

CB 240 climbing cycle sequence

1. The first wall section is concreted.
Install the leading anchor according to specifications.

2. After reaching the required concrete strength, mount the Scaffold Mounting Ring M24 and then attach the pre-assembled scaffold unit. Install the formwork and concrete the second section.

3. Retract the formwork and then mount the Scaffold Mounting Ring M24.

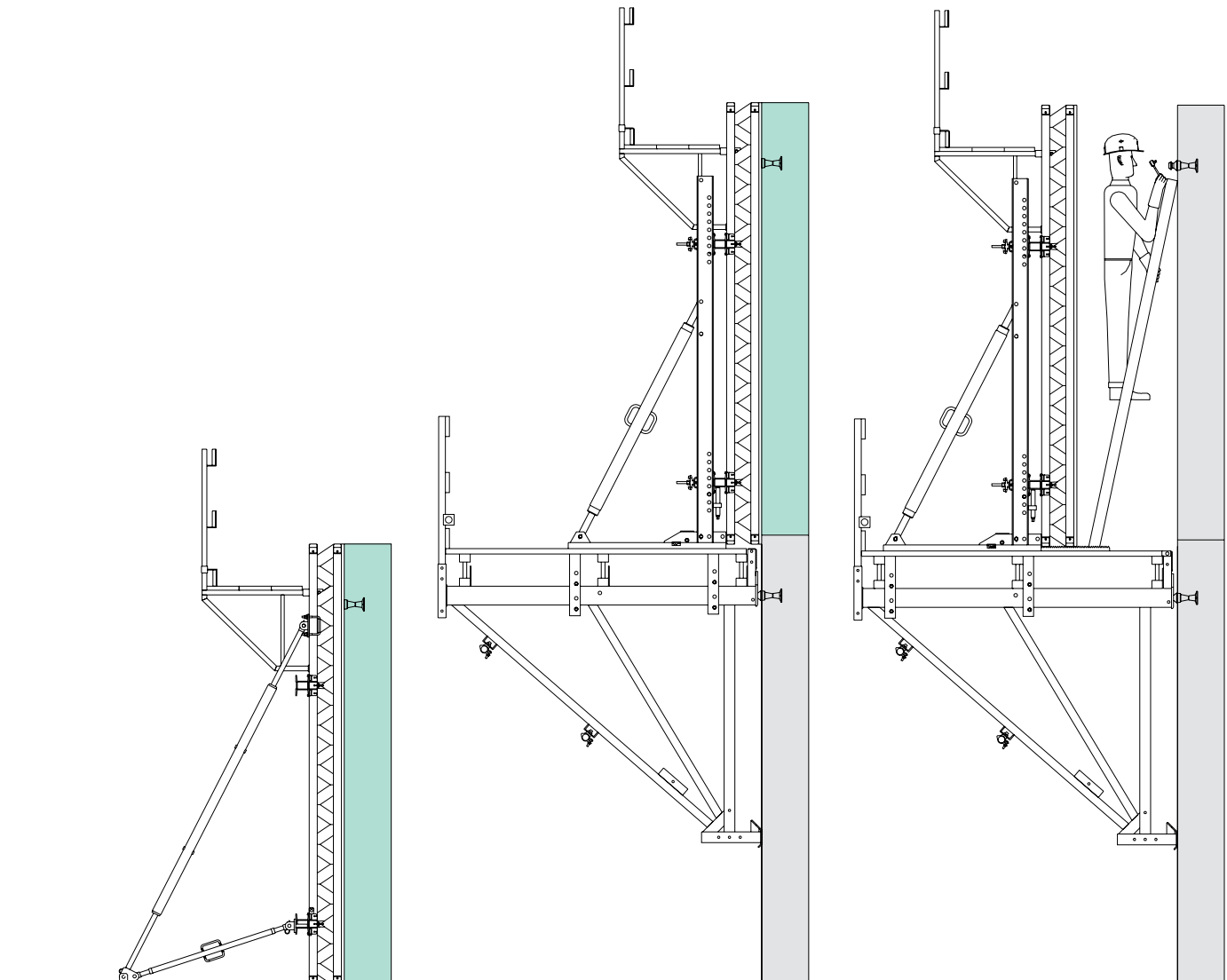

4. Lift the complete unit to the next section by means of the crane.
If required, the finishing platform can be fitted.

5. Reinforcement work is now carried out and, if required, the formwork is placed at an angle.

6. Move the formwork forwards and concrete. At this point cycles continue as in Point 3.

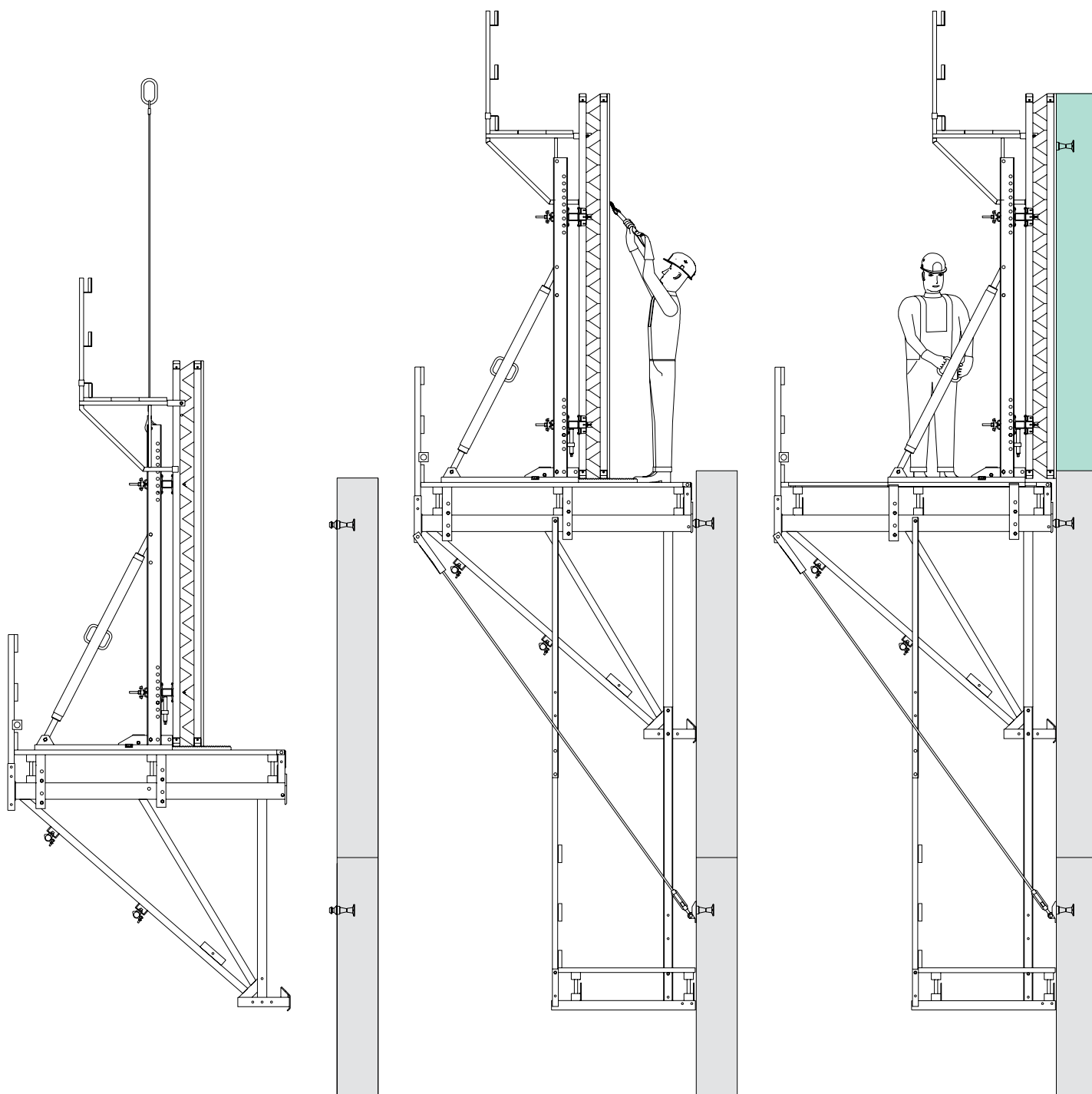

Climbing System CB

Application and moving procedure of CB 160

Application CB 160

The formwork is simply tilted backwards when striking. With a platform width of 1.60 m, a sufficient working area is available.

With the Adjusting Unit CB 160 the formwork is pushed tight to the previous concrete section.

CB 160 combined with CB 240

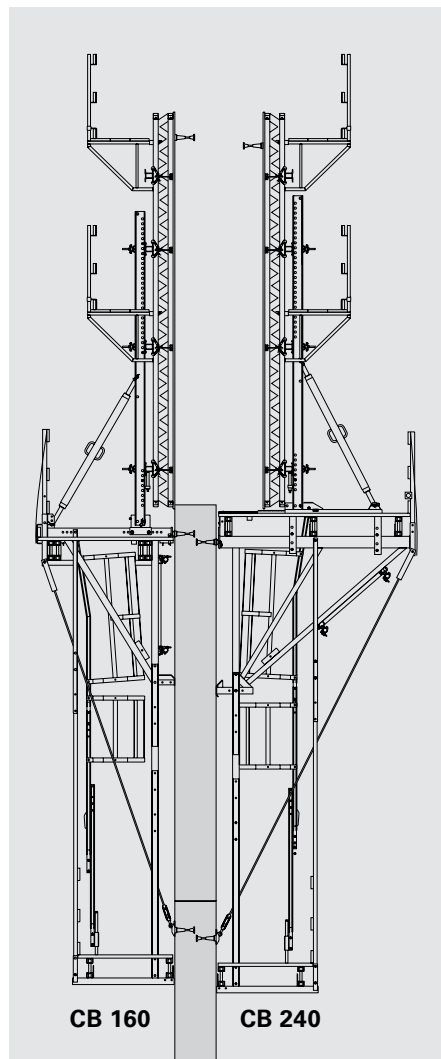

Safe working conditions also on the CB 160 climbing system. An integrated ladder allows safe and secure access to the finishing platform.

Adjusting Unit CB 160
Item no. 051130

Ratchet Lever SW 19
Item no. 027180

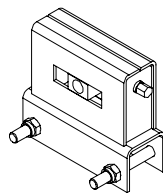

Combining CB 160 and CB 240 is the cost-effective solution for high walls.

**CB 160
moving procedure**

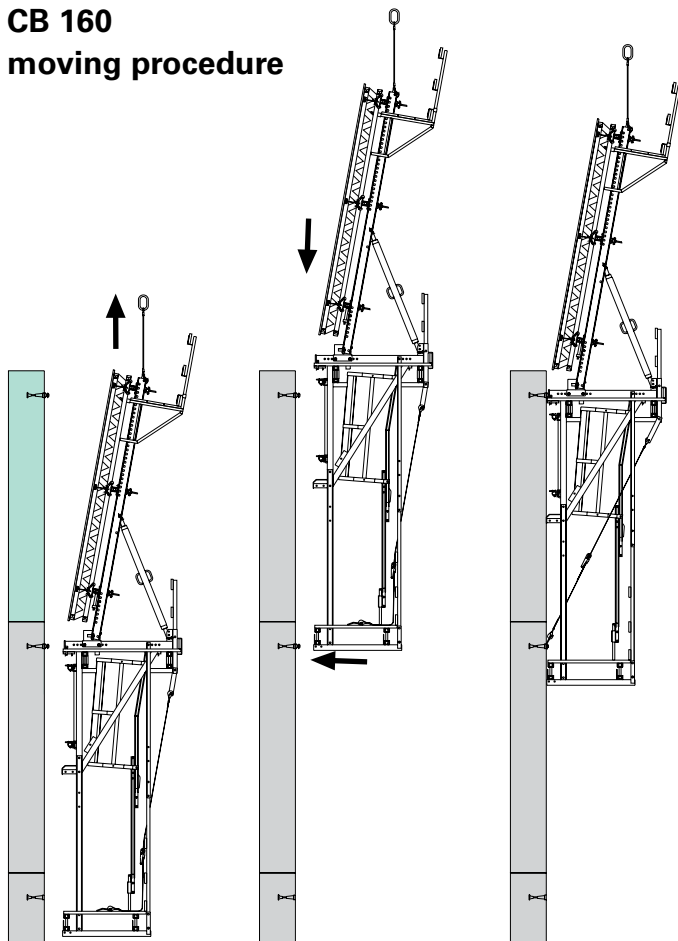

1. Lift the unit with the crane.

2. Lift and then place in position.

3. Attach unit on the Scaffold Mounting Ring M24.

**Moving procedure with
Climbing Traverse RCS**

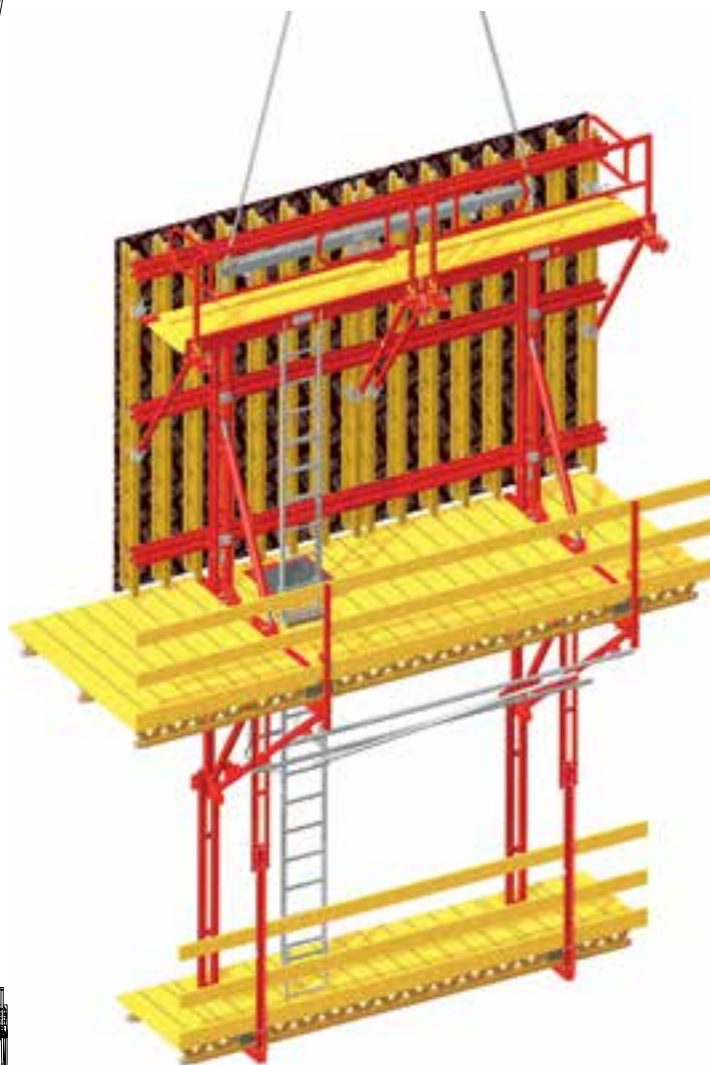

The PERI Climbing Traverse RCS 10 t, Item no. 112986, is used when moving larger or non-symmetrical units.

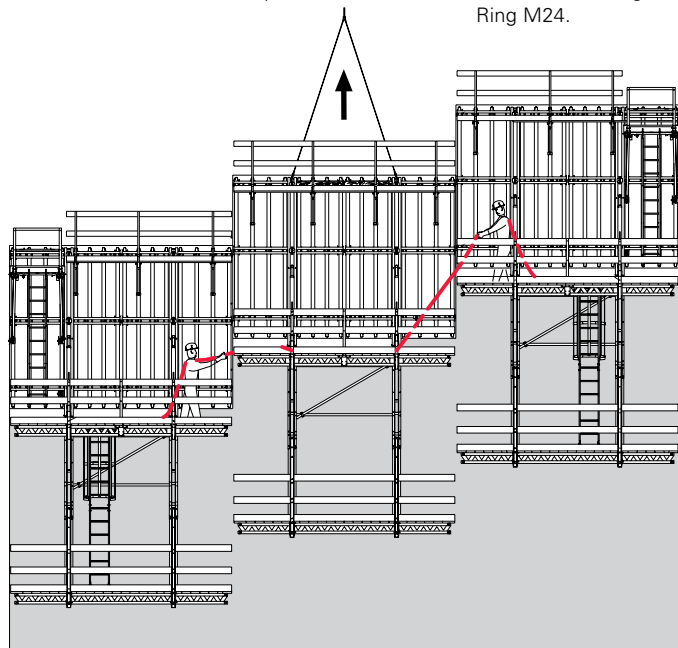

Use a guide rope to ensure that the moving procedure is fully under control.

Climbing System CB

Certified scaffold anchorage

With climbing systems, safety is significantly determined by the quality of the anchoring system used. Therefore, the PERI anchoring systems have been officially approved.



PERI anchoring systems have been officially approved.







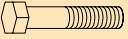

The PERI Climbing Anchor M24/DW 15 and M24/DW 20 are efficient in their use as well as guaranteeing safe handling.

Version 1

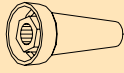
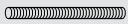
Standard anchoring with variable anchoring depth.
With PERI Climbing Cone-2 M24/DW 15 Building Authority Approval No. Z-21.6-1767.

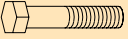
Version 2

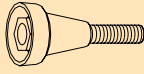
Anchoring for thin walls and limited anchor forces.
With PERI Screw-On Cone-2 M24/DW 20 Building Authority Approval No. Z-21.6-1766.

System	Reusable components			Lost components	
M24/DW 15	 M24x120-10.9 Item no. 029560	 Scaffold Mounting Ring M24 Item no. 029470	 Climbing Cone-2 M24/DW 15 Item no. 031220	 Tie Rod DW 15 Item no. 030030	 Threaded Anchor Plate 15 Item no. 030840
M24/DW 20	 M24x120-10.9 Item no. 029560	 Scaffold Mounting Ring M24 Item no. 029470	 Screw-On Cone-2 M24/DW 20 Item no. 030960		 Threaded Anchor Plate 20 Item no. 030860

Version 1, shown with CB 240

With PERI Climbing Cone-2 M24/DW 15 and Threaded Anchor Plate 15.

Version 2, shown with CB 160

With PERI Screw-On Cone-2 M24/DW 20 and Threaded Anchor Plate 20.

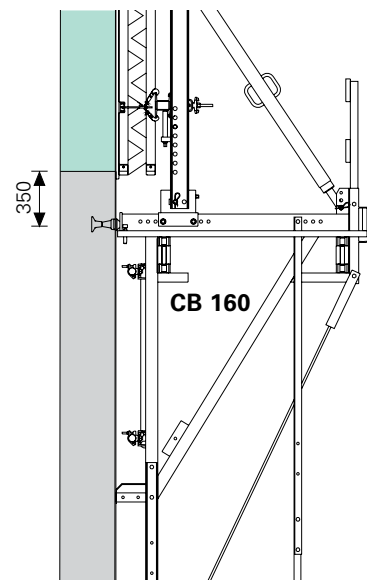
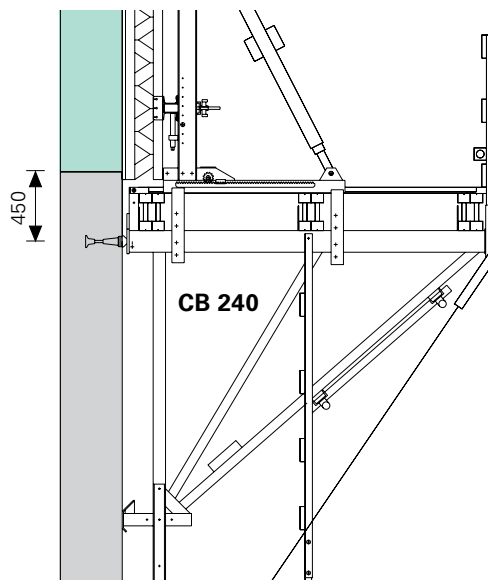

Mounting of leading anchor Advancing Bolt M24

Plywood is drilled through.
E.g. with Wall Formwork VARIO GT 24.

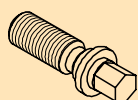

1. Leading anchor during striking

Position leading anchor drill through plywood \varnothing 25 mm. Screw climbing anchor and Advancing Bolt tightly together.

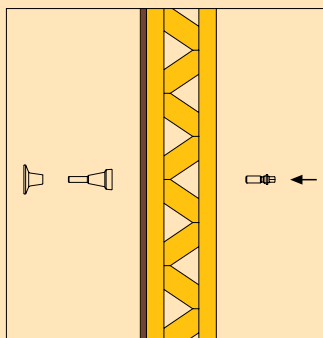

2. Attach scaffold suspension

Remove Advancing Bolt M24. Retract formwork. Attach Scaffold Mounting Ring M24 with Hex. Bolt M24 x 120.

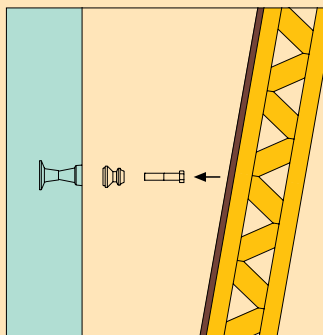

Anchor Positioning M24

Plywood is not drilled through.
E.g. with panel formwork MAXIMO, TRIO.



1. Leading anchor during striking

Position Anchor Positioning M24 and fix by nailing into the plywood. Turn Climbing Anchor on the Anchor positioning. Secure the Threaded Anchor Plate by means of tie wire to the reinforcement.

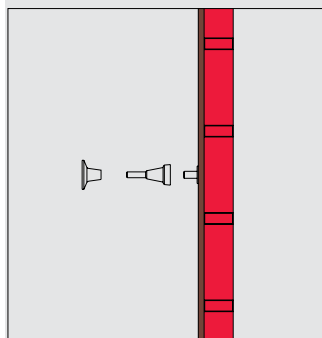

2. Attach scaffold suspension

Release the formwork from the concrete and retract (the nails are pulled through the plywood). Dismantle Anchor Positioning M24 using a pin wrench SW 14. Mount Scaffold Mounting Ring M24 using a Hex. Bolt M24 x 120.

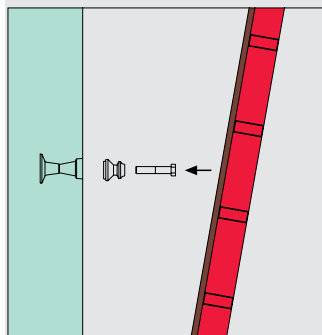

3. Mount scaffold brackets

Mount Scaffold Brackets CB 240 or CB 160 and immediately secure by means of safety pins.

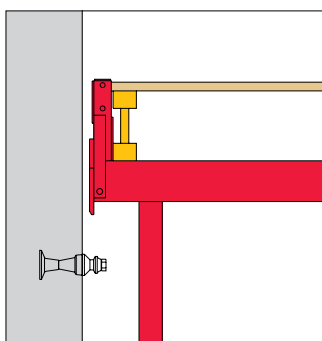

4. Reusable anchor components

Screw out the Hex. Bolt M24 x 120 and cone from the finishing platform using the socket wrench SW 36.

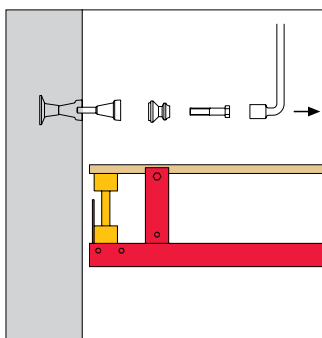

5. Close anchor points

The remaining anchor hole is closed by means of the Concrete Cone KK. This results in an optically-pleasing concrete surface.



Climbing System CB

High level of working safety with system components

The system components for the CB 240 and CB 160 climbing systems provide a very high degree of safety.

Integrated ladders with hinged hatches and ladder cages ensure safe access to the finishing and concreting platforms. Handrail post for fixing the end and side handrails.



Using VARIO platforms, the CB 240 climbing system ensures safe access to the concreting level.



Accessing the two finishing platforms is carried out with CB 240 and CB 160 system components.

Easy access to the finishing platform with the PERI ladder.

Access Ladder

Safe and secure access to the CB 240 and CB 160 finishing platform at all heights.

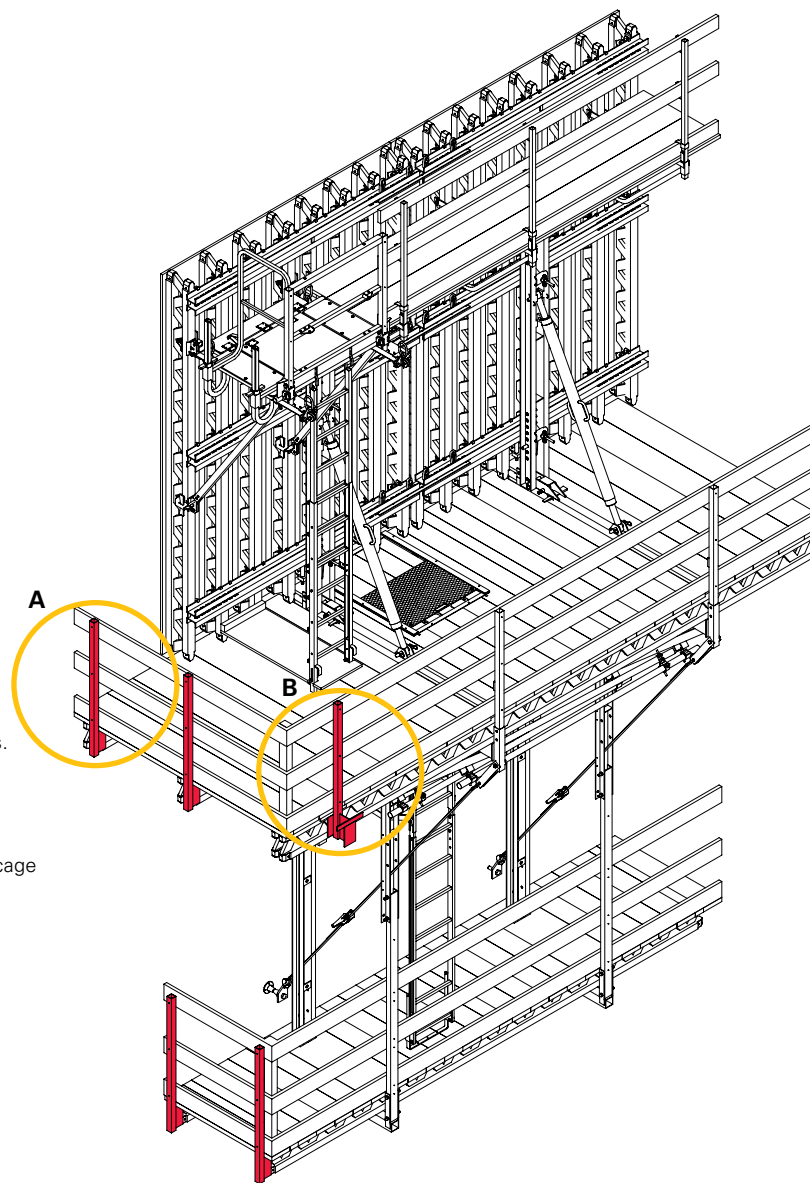
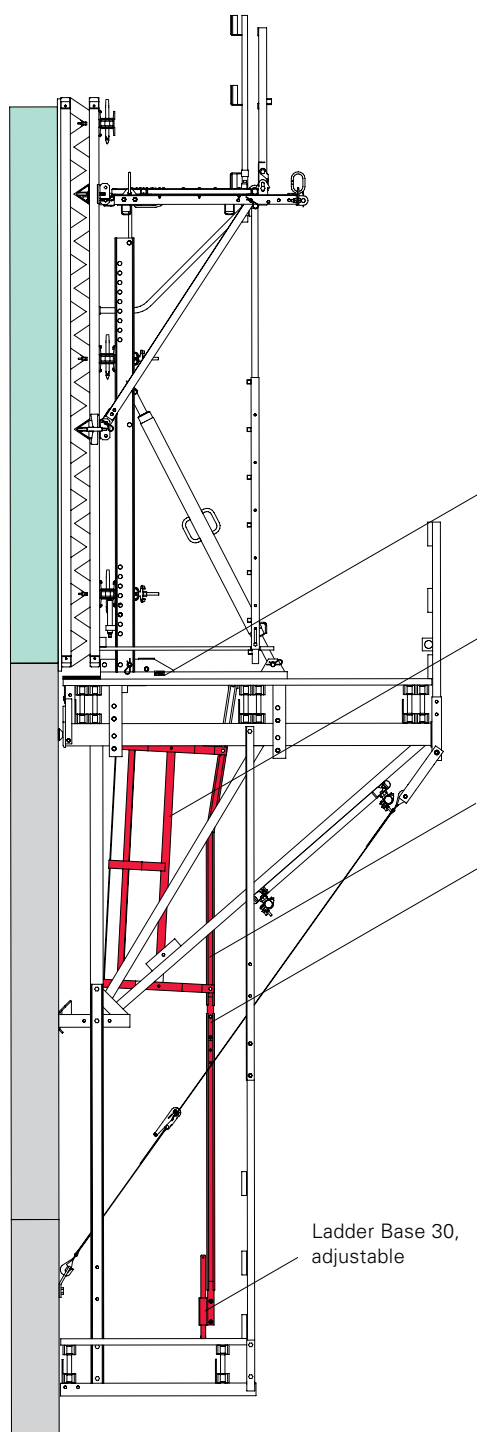

A) Side handrail post
For fixing end handrails.
It is mounted on the outer main beam at the end.

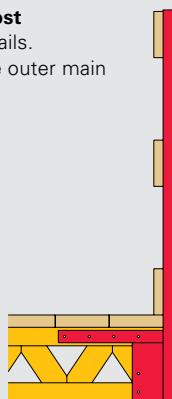

B) End handrail post
With larger cantivers, it is attached to the outer main beam.

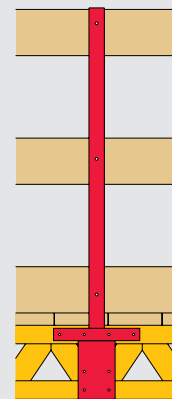

BR shaft platforms

Safe support for inside shaft formwork

Application

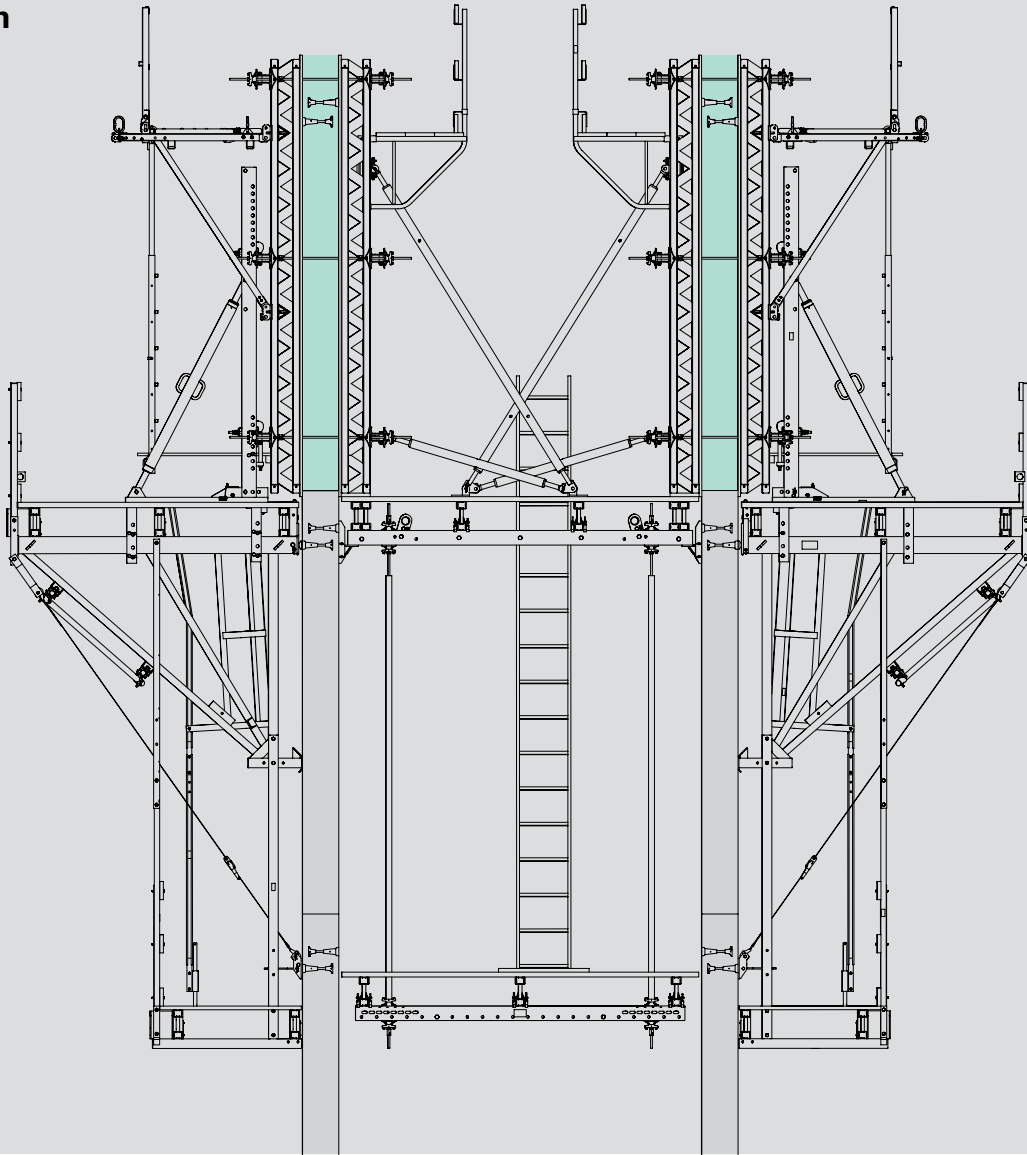

The BR shaft platform serves as support for inside shaft formwork panels. It consists of Platform Beams BR exactly tailored to the size of the particular shaft. The planking is supported by Girders GT 24 or timbers attached by hook straps to the Platform Beam.

The support of the shaft platform is provided by Folding Brackets 25 bolted to embed climbing anchors e.g. Anchor Sleeve M24.

Alternatively Gravity Pivot Plates are attached to the Platform Beam, engaging into reusable cast-in Bearing Boxes BR.

Support on Folding Bracket 25

Perm. load-bearing capacity 25 kN

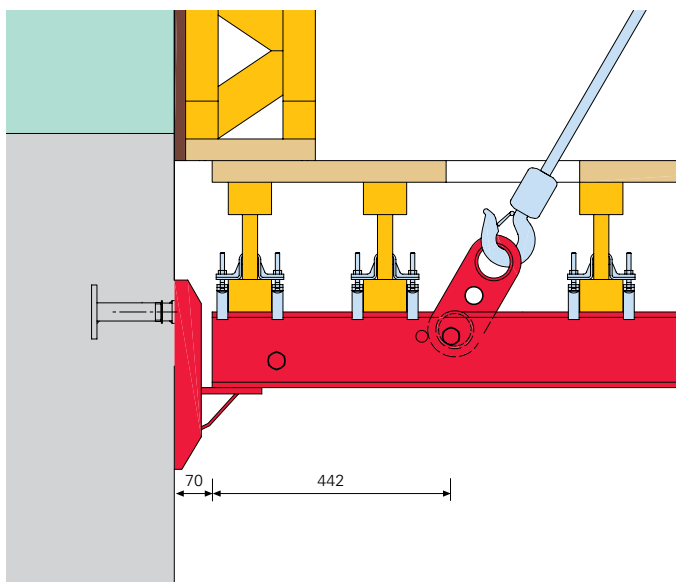

Support on gravity pivot plate

Perm. load-bearing capacity max. 38 kN

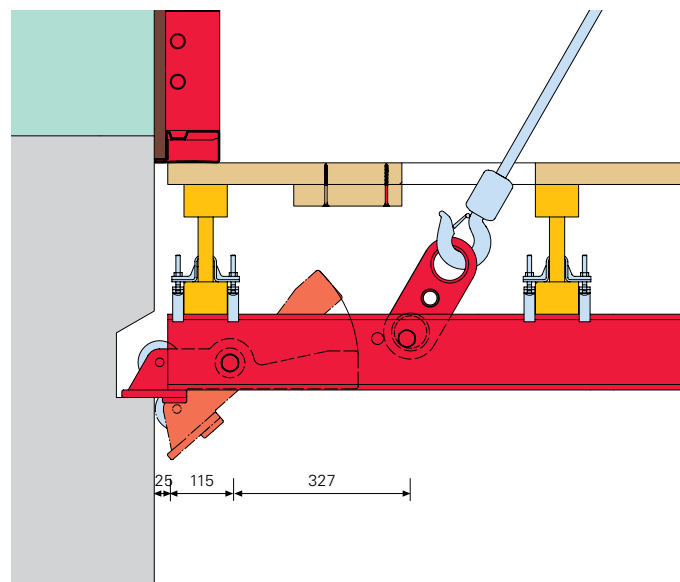

Assembly sequence

Platform Beam BR with gravity pivot plate

1. Bearing Box BR installed

2. Struck

3. Platform supported

4. Platform lifted

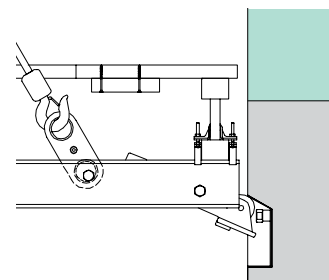
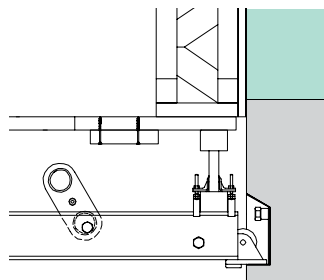
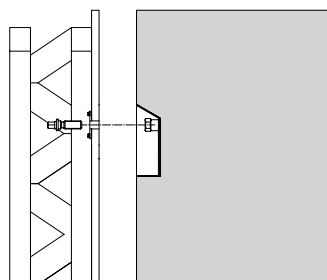
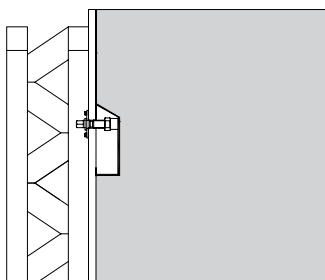

Installation of platform decking

1. With Girder GT 24

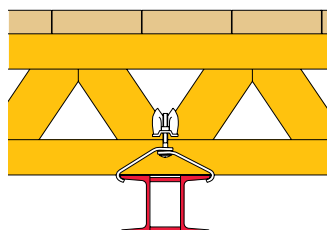
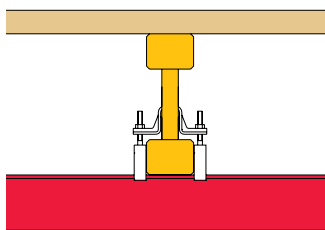

2. With square-shaped timber

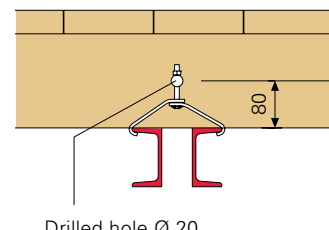
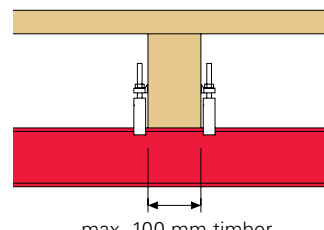

Hook Strap HB 24-100/120
for Profile U 100 / U 120
Hook Strap HB 24-140/160
for Profile U 140 / U 160

Hook Strap HB 24 QB 150, galv.
for Profile U 100 / U 120
Hook Strap Uni HBU
for Profile U 100 – U 160

Item no.	Weight kg
051000	112,000

Climbing Bracket CB 240

Complete Climbing Scaffold Bracket CB 240.

Complete with

- 2 pc. 017040 Screw-On Coupler AK 48, galv.
- 1 pc. 715977 Guardrail Post CB 240
- 1 pc. 710222 Bolt ISO 4014 M16 x 80-8.8, galv.
- 1 pc. 070890 Nut ISO 7042 M16-8, galv.

Note

Delivery condition: handrail post in transport securing device.

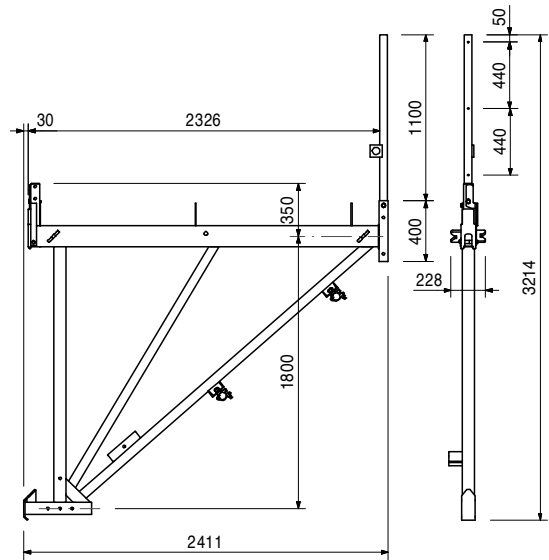
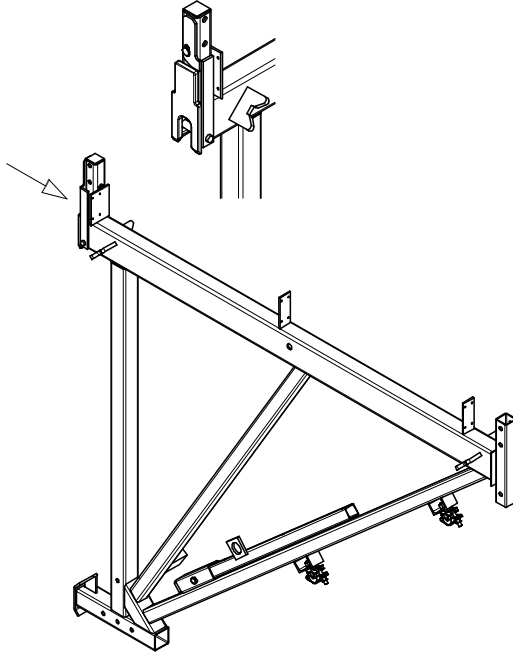

051020	33,900
--------	--------

Carriage CB 240

For assembly on the Climbing Bracket CB 240.
Can be installed in 2 positions: for decking support with GT 24 girder or timber 8 x 16.

Complete with

- 1 pc. 710944 Key Wedge, FW
- 1 pc. 710859 Axle \varnothing 25 x 184
- 1 pc. 710866 Cog-Wheel \varnothing 25
- 1 pc. 710914 Split Pin ISO 8752 8 x 45, galv.

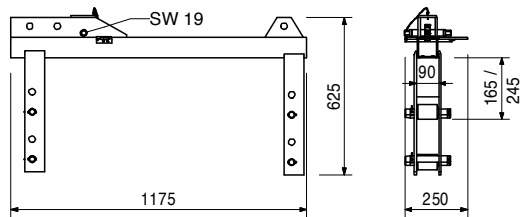
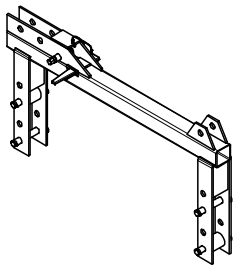

Accessories

027180	1,760
051040	8,440

Ratchet Lever SW 19

Rack CB 240

Item no.	Weight kg
051040	8,440

Rack CB 240
For Carriage CB 240.

Complete with
1 pc. 018050 Pin \varnothing 16 x 65/86, galv.
1 pc. 018060 Cotter Pin 4/1, galv.

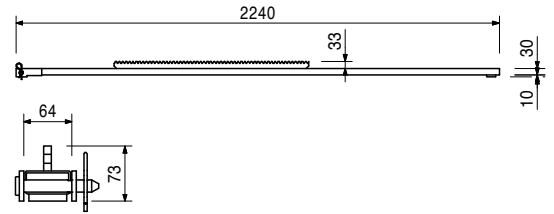
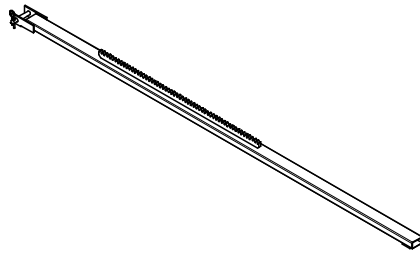

127821	0,957
--------	-------

Crane Eye CB 240-2 0.7 t
For assembly on the Climbing Bracket CB 240 when used as working scaffold.

Complete with
1 pc. 128335 Bolt ISO 4015 M16 x 110
1 pc. 126248 Castle Nut M16 DIN 935-8, galv.
1 pc. 722825 Cotter Pin ISO 1234-04, 0 x 030 St

Note

Follow Instructions for Use!

Technical Data

Permissible load-bearing capacity 700 kg.

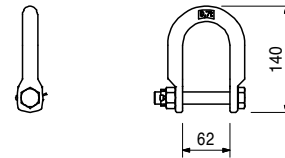

051100	79,200
--------	--------

Climbing Bracket CB 160
Complete Climbing Scaffold Bracket CB 160.

Complete with
2 pc. 017040 Screw-On Coupler AK 48, galv.
1 pc. 701209 Guardrail Post CB 160
1 pc. 710222 Bolt ISO 4014 M16 x 80-8.8, galv.
1 pc. 070890 Nut ISO 7042 M16-8, galv.

Note

Delivery condition: handrail post in transport securing device.

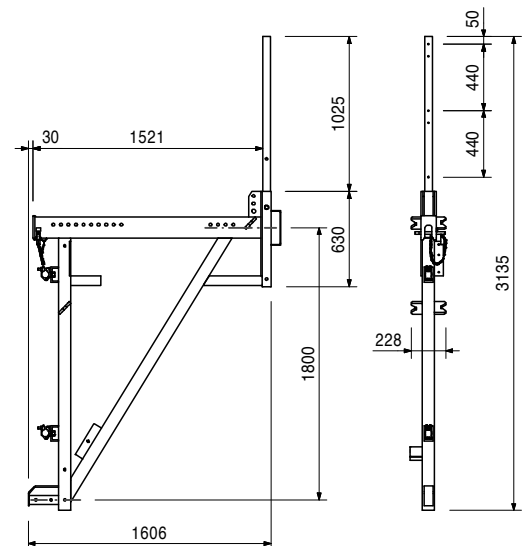
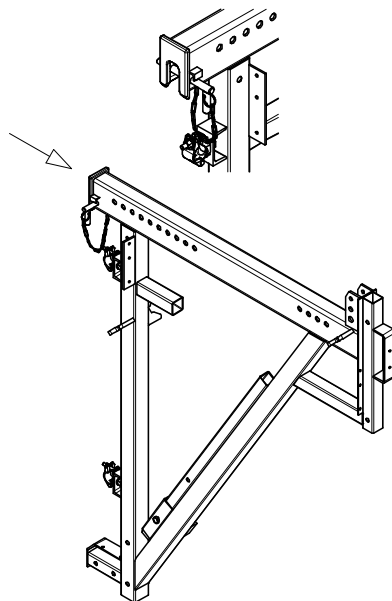

Item no.	Weight kg
051130	12,900

Adjusting Unit CB 160

For Climbing Bracket CB 160.

Complete with

2 pc. 711084 Bolt ISO 4014 M20 x 150-8,8, galv.
2 pc. 781053 Nut ISO 7042 M20-8, galv.

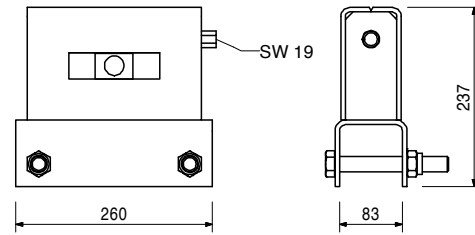
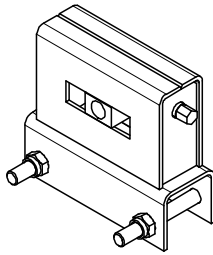

051120	4,570
--------	-------

Platform Connection CB 160

For mounting platform decking on the Climbing Bracket CB 160 when used as working scaffold.

Complete with

2 pc. 711078 Bolt ISO 4014 M20 x 130-8,8, galv.
2 pc. 781053 Nut ISO 7042 M20-8, galv.

Note

Follow Instructions for Use!

Technical Data

Permissible load-bearing capacity 500 kg.

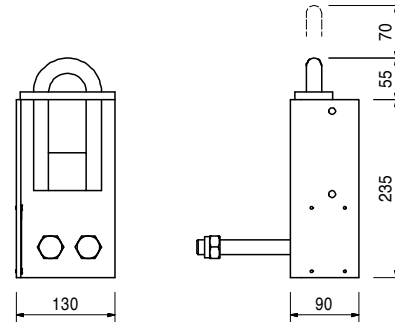
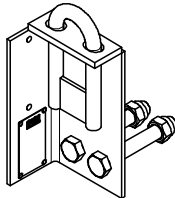

051060	73,400
051150	103,000

Strongbacks CB

Strongback CB 270

Strongback CB 380

For assembling system formwork on Climbing Brackets CB 240 and 160. For formwork heights up to 5.40 m.

Complete with

1 pc. 715936 Pin Ø 25 x 180, incl. dowel pin Ø 6
1 pc. 018060 Cotter Pin 4/1, galv.

Technical Data

Permissible load-bearing point capacity 1.9 t.

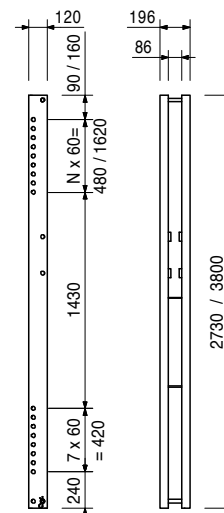

Item no.	Weight kg
051030	5,320

Height Adjusting Unit CB, SCS

For height adjustment of VARIO GT 24 panels on the Strongbacks CB and SCS.

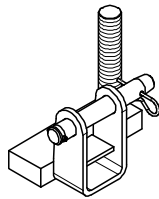

Complete with

1 pc. 715936 Pin Ø 25 x 180, incl. dowel pin Ø 6
1 pc. 018060 Cotter Pin 4/1, galv.

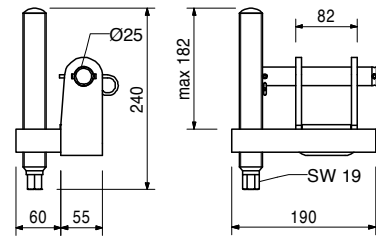

051110	24,900
--------	--------

Adjustable Brace CB 164-224

For aligning the Strongback CB.

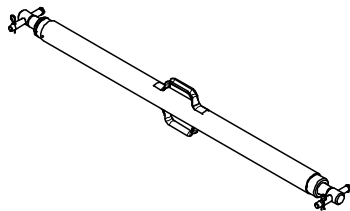

Complete with

2 pc. 715936 Pin Ø 25 x 180, incl. dowel pin Ø 6
2 pc. 018060 Cotter Pin 4/1, galv.

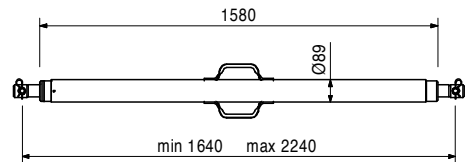

051090	13,500
--------	--------

Connector TRIO-CB

For fixing TRIO panels to the Strongback CB. Used on horizontal or vertical struts. With integrated height adjustment.

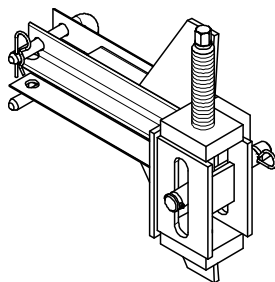

Complete with

1 pc. 715936 Pin Ø 25 x 180, incl. dowel pin Ø 6
1 pc. 018060 Cotter Pin 4/1, galv.

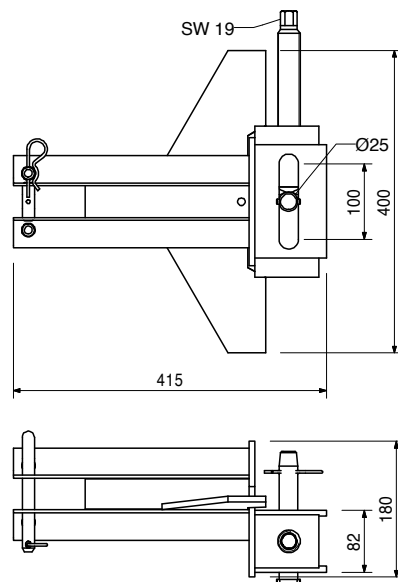

Item no.	Weight kg
110059	2,840

Waler Fixation U100 – U120

For fixing VARIO GT 24 panels to Strongbacks CB or SCS and Steel Waler SRU.

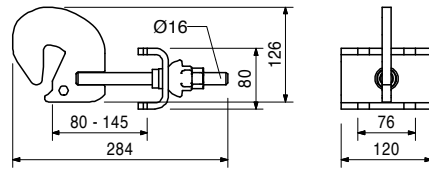
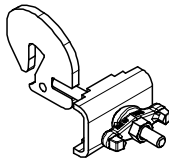

051230	17,000
--------	--------

Finishing Platform Beam CB

For assembling finishing platforms.

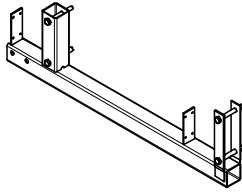

Complete with

4 pc. 710232 Bolt ISO 4014 M16 x 130-8.8, galv.
4 pc. 070890 Nut ISO 7042 M16-8, galv.

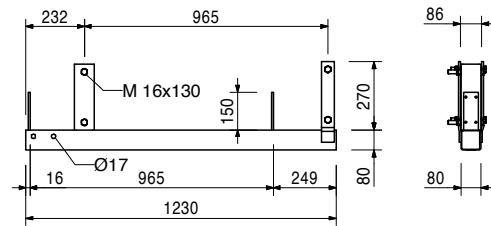

051200	44,400
--------	--------

Platform Post CB 225

For assembling finishing platforms. For concreting heights up to 3.60 m. In combination with Post Extension CB 180 for concreting heights from 3.60 to 5.40 m.



Complete with

2 pc. 710232 Bolt ISO 4014 M16 x 130-8.8, galv.
2 pc. 070890 Nut ISO 7042 M16-8, galv.

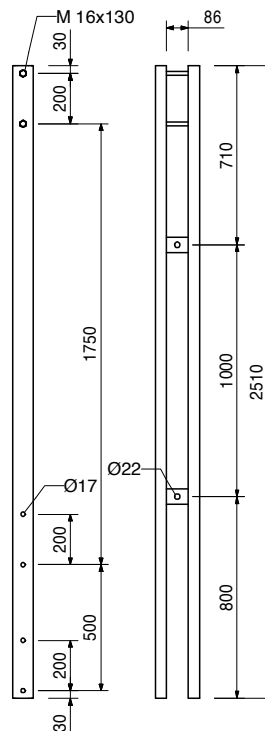

Item no.	Weight kg
051050	26,400

Post Extension CB 180

For assembling finishing platforms. In combination with Platform Post CB 225 for concreting heights from 3.60 to 5.40 m.

Complete with

2 pc. 710232 Bolt ISO 4014 M16 x 130-8.8, galv.
2 pc. 070890 Nut ISO 7042 M16-8, galv.

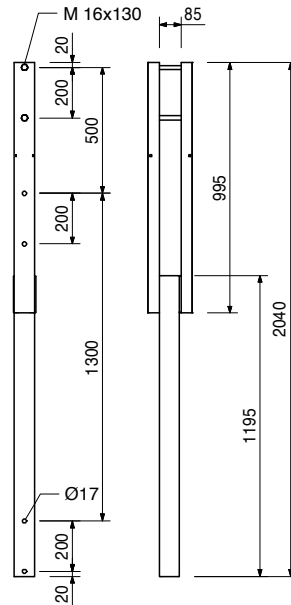

051190	17,400
--------	--------

Handrail Post CB 200

For assembling guardrails on finishing platforms. Basic extension for Handrail Post CB 190 and 370.

Complete with

2 pc. 710232 Bolt ISO 4014 M16 x 130-8.8, galv.
2 pc. 070890 Nut ISO 7042 M16-8, galv.

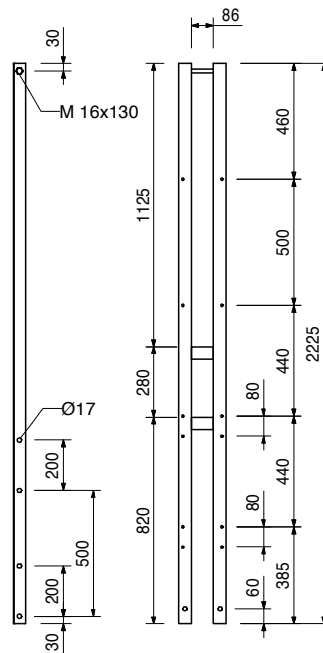
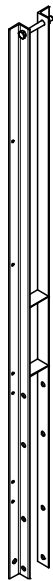

Item no.	Weight kg
051210	19,000
051220	34,600

Handrail Posts CB
Handrail Post CB 190
Handrail Post CB 370

For assembling guardrails on finishing platforms.
 Handrail Post CB 190 for concreting heights up to 3.60 m. Handrail Post CB 370 for concreting heights from 3.60 to 5.40 m.

Complete with

2 pc. 710232 Bolt ISO 4014 M16 x 130-8.8, galv.
 2 pc. 070890 Nut ISO 7042 M16-8, galv.

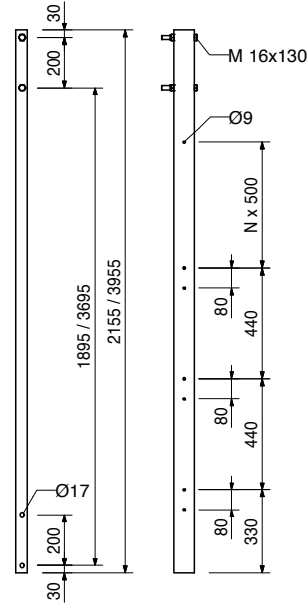

Item no.	Weight kg	Description
026415	3,550	Scaffold Tubes Steel Ø 48.3 x 3.2
026417	0,000	Scaff. Tube Steel Ø 48.3 x 3.2, special length
026411	3,550	Cutting Cost Scaffold Tube
026412	7,100	Scaff. Tube Steel Ø 48.3 x 3.2, l = 1.0 m
026413	10,650	Scaff. Tube Steel Ø 48.3 x 3.2, l = 2.0 m
026414	14,200	Scaff. Tube Steel Ø 48.3 x 3.2, l = 3.0 m
026419	17,750	Scaff. Tube Steel Ø 48.3 x 3.2, l = 4.0 m
026418	21,600	Scaff. Tube Steel Ø 48.3 x 3.2, l = 5.0 m
		Scaff. Tube Steel Ø 48.3 x 3.2, l = 6.0 m

L

- 1000
- 2000
- 3000
- 4000
- 5000
- 6000

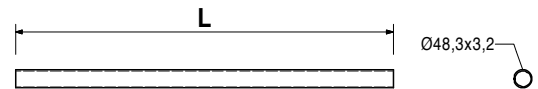
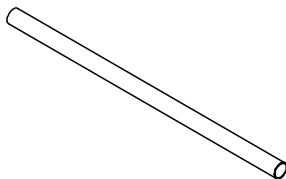

017010	1,400	Swivel Coupling DK 48/48, galv. For Scaffold Tubes Ø 48 mm.
--------	-------	---

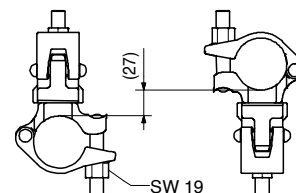
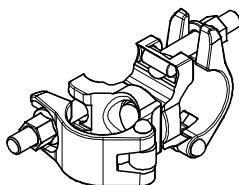

Item no.	Weight kg
017040	0,850

Screw-On Coupler AK 48, galv.
For Scaffold Tubes \varnothing 48 mm.

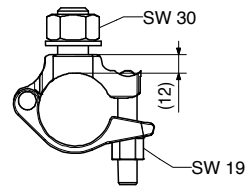
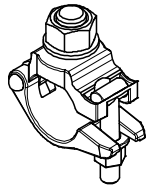

051160	0,894
--------	-------

Guardrail Connector CB
For assembling scaffold tubes on handrail posts.

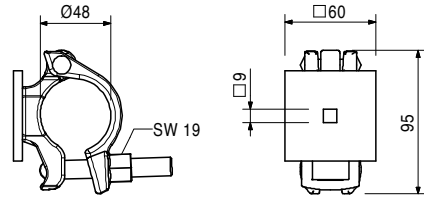
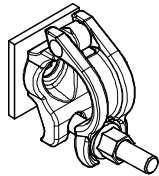

Accessories

126228	0,030
--------	-------

F.H. Bolt DIN 603 M8 x 70 MU, galv.

051610	6,940
--------	-------

Side Guardrail Post CB
For assembly of an end guardrail. Bolted to the platform main beam.

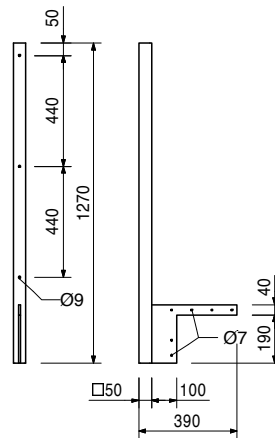
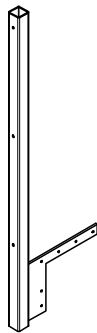

Accessories

051640	0,014
--------	-------

Lag Screw DIN 571 6 x 80, galv.

Item no.	Weight kg
051630	11,000

Intermediate Handrail Post CB

For assembling a guardrail with large cantilevers.
Bolted on the platform main beam.

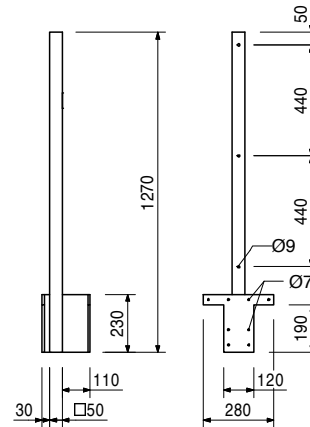
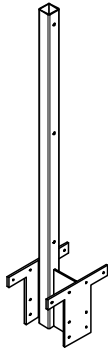

Accessories

051640	0,014
051610	6,940

Lag Screw DIN 571 6 x 80, galv.
Side Guardrail Post CB

126399	4,710
--------	-------

Handrail Post Extension CB

For the extension of guardrail post CB by 50 cm.

Complete with

1 pc. 710222 Bolt ISO 4014 M16 x 80-8.8, galv.
1 pc. 070890 Nut ISO 7042 M16-8, galv.

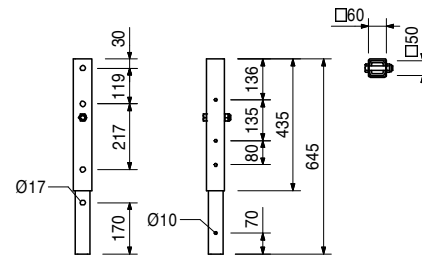

065066	15,100
--------	--------

End Guardrail Frame 55

Clampable end guardrail for all PERI scaffold platforms and climbing systems.

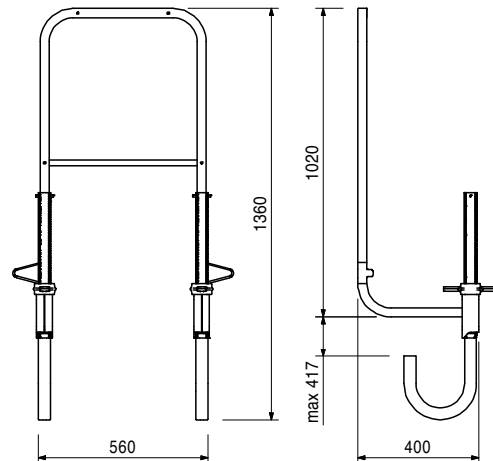
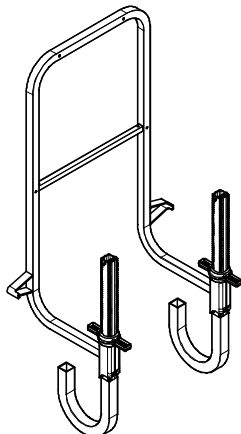

Item no. Weight kg

051640 0,014 **Lag Screw DIN 571 6 x 80, galv.**

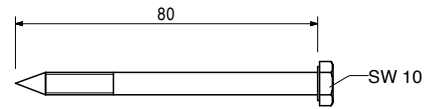
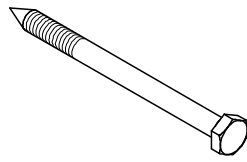

051650 0,060 **F.H. Bolt DIN 603 M6 x 180 MU, galv.**

With nut.

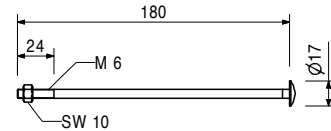
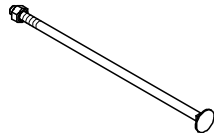

710240	0,050	F.H. Bolts DIN 603 M8, galv.
024360	0,058	F.H. Bolt DIN 603 M8 x 100 MU, galv.
108834	0,085	F.H. Bolt DIN 603 M8 x 125 MU, galv.
		F.H. Bolt DIN 603 M8 x 180 MU, galv.

With nut.



L	B
100	80
125	113
180	28

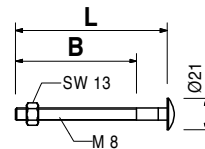

029470 0,723 **Scaffold Mounting Ring M24, galv.**

Anchor System M24.
For anchoring climbing systems.

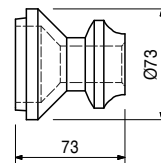
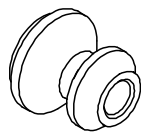

Accessories

029560 0,535 **Bolt ISO 4014 M24 x 120-10.9**

029560 0,535 **Bolt ISO 4014 M24 x 120-10.9**
High-strength bolts for anchoring climbing systems.

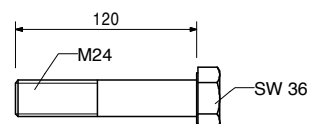
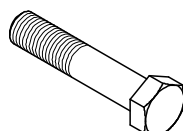

Item no.	Weight kg
114158	1,030

Screw-On Cone-2 M24/DW 20, galv.
Anchor system M24.
For anchoring climbing systems.

Note
Separate design information on request.

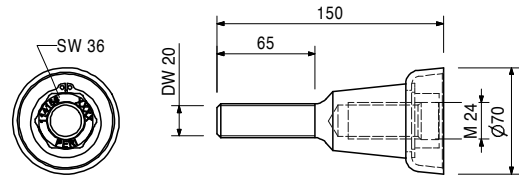
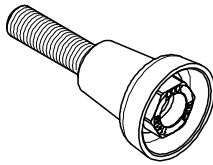

Accessories

030860	0,801
--------	-------

Threaded Anchor Plate DW 20

030860	0,801
--------	-------

Threaded Anchor Plate DW 20
For use with Tie Rod DW 20, B 20 or Screw-On Cone-2 M24/DW 20. For anchoring in concrete.

Note
Lost anchor part.

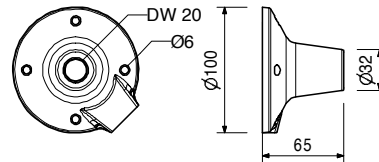
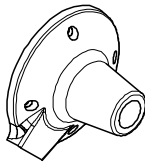

031220	1,010
--------	-------

Climbing Cone-2 M24/DW 15, galv.
Anchor system M24.
For anchoring climbing systems.

Note
Separate design information on request.

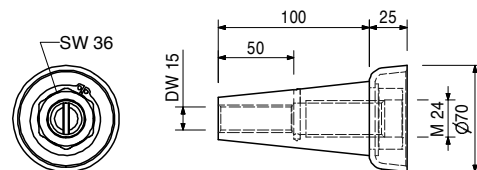
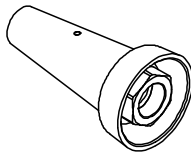

Accessories

030840	0,516
030030	1,440
030740	1,550

Threaded Anchor Plate DW 15
Tie Rod DW 15, Spec. Length
Tie Rod B 15, Spec. Length

030840	0,516
--------	-------

Threaded Anchor Plate DW 15
For use with Tie Rod DW 15 or B 15. For anchoring in concrete.

Note
Lost anchor part.

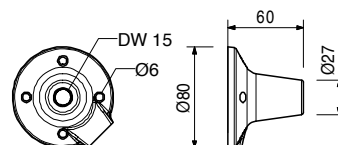
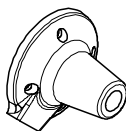

Item no.	Weight kg
030030	1,440
030050	0,000

Tie Rods DW 15
Tie Rod DW 15, Spec. Length
Cutting Cost Tie Rod DW 15, B 15

Note
 Non-weldable! Take official approval into consideration!
Technical Data
 Permissible tension force 90 kN.

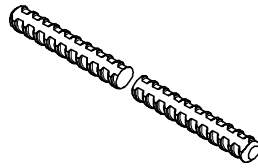

030740	1,550
030050	0,000

Tie Rods B 15
Tie Rod B 15, Spec. Length
Cutting Cost Tie Rod DW 15, B 15

Note
 Weldable! Take official approval into consideration!
Technical Data
 Permissible tension force 82 kN.

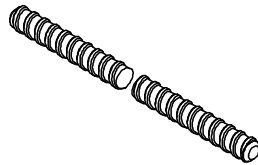

031652	0,247
--------	-------

KK Concrete Cone M24-67/52
 For closing anchor points with Climbing Cone-2, M24/DW 15 and Screw-On Cone-2 M24/DW 20.

Note
 Delivery unit 50 pieces.

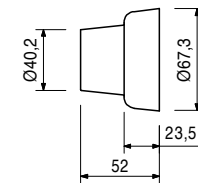
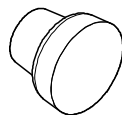

Accessories

108136	5,000
--------	-------

Glue for Concrete Cones-2, 5-kg-Set

029270	0,331
--------	-------

Advancing Bolt M24, galv.
 For fixing the M24 anchor system if the plywood formlining is drilled through.

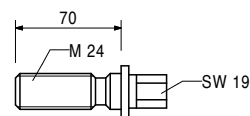
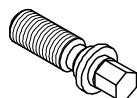

Accessories

029280	0,196
--------	-------

Anchor Positioning Plate M24, galv.

Item no.	Weight kg
029280	0,196

Anchor Positioning Plate M24, galv.

For fixing the M24 anchor system if the plywood formlining is drilled through.

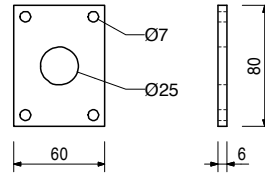
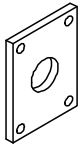

Accessories

029440	0,005
--------	-------

Lag Screw DIN 571 6 x 20, galv.

029440	0,005
--------	-------

Lag Screw DIN 571 6 x 20, galv.

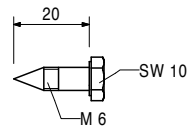

026420	0,123
--------	-------

Anchor Positioning Stud M24, galv.

For fixing the M24 anchor system if the plywood formlining is not drilled through.

Note

Allen Key SW 14.

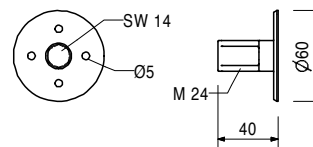

Accessories

027212	0,445
710312	0,005

Allen Key SW 14, long

Nail 3 x 80

107007	3,410
--------	-------

Tension Anchor Connector CB

To prevent tipping over due to wind loads with Tie Rod DW 15.

Complete with

1 pc. 710219 Bolt ISO 4014 M16 x 100-8.8, galv.

1 pc. 070890 Nut ISO 7042 M16-8, galv.

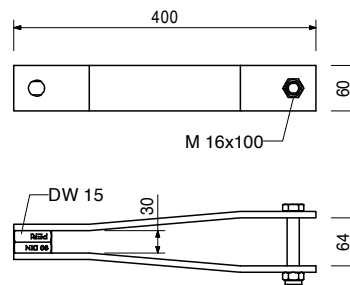
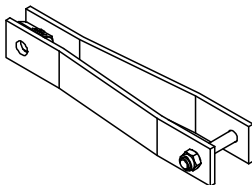

Accessories

116807	1,820
030030	1,440
107008	4,100
116752	5,050

Turnbuckle CB M20/DW 15

Tie Rod DW 15, Spec. Length

Wall Tension Anchor

Wall Bracing Shoe CB M24

Item no.	Weight kg
116807	1,820

Turnbuckle CB M20/DW 15

For tensioning of Tie Rod DW 15 to prevent tipping over due to wind loads. Connects Tie Rod DW 15 with Wall Bracing Shoe CB M24.

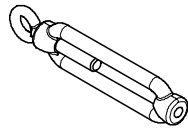

Complete with

1 pc. 711059 Turnbuckle for tension anchor CB
1 pc. 711060 Eye Bolt M20, left, galv.

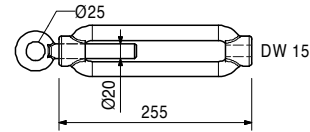

107008	4,100
--------	-------

Wall Tension Anchor

Alternative wall connector to prevent tipping over due to wind loads with Tie Rod DW 15. Including Turnbuckle CB M20/DW 15.

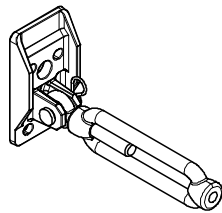

Complete with

1 pc. 027170 Pin Ø 16 x 42, galv.
1 pc. 018060 Cotter Pin 4/1, galv.

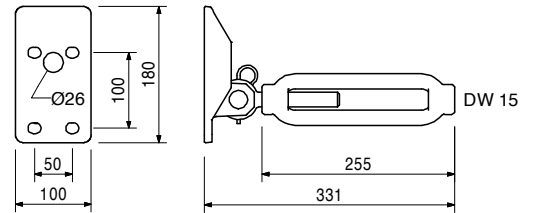

Accessories

026430	0,334
--------	-------

Bolt ISO 4014 M24 x 70-10.9

051260	3,300
--------	-------

Tension Belt Connector CB

To prevent tipping over due to wind loads with tension belt.

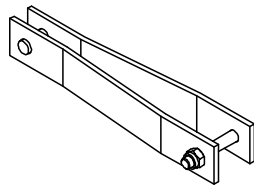

Complete with

1 pc. 710219 Bolt ISO 4014 M16 x 100-8.8, galv.
1 pc. 070890 Nut ISO 7042 M16-8, galv.

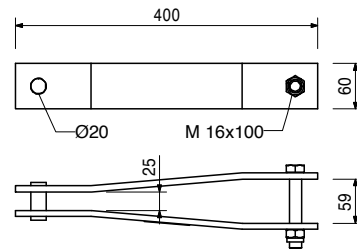

Accessories

051250	2,790
051270	1,620
116752	5,050

Tension Belt, l = 5.70 m, 2.5 t

Tension Belt Connector Wall M24

Wall Bracing Shoe CB M24

Item no.	Weight kg
051250	2,790

Tension Belt, l = 5.70 m, 2.5 t

To prevent climbing systems from tipping over due to wind loads.

Note

Follow Instructions for Assembly and Use!

Technical Data

Permissible tension force 2.5 t.

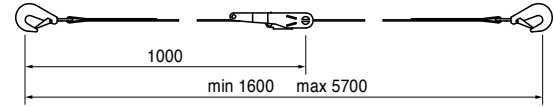
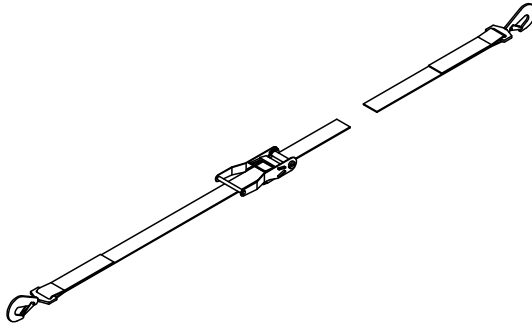

051270	1,620
--------	-------

Tension Belt Connector Wall M24

Wall connector to prevent tipping over due to wind loads with Tension Belt. To be used for climbing systems CB and FB.

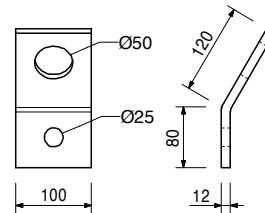
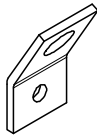

Accessories

026430	0,334
--------	-------

Bolt ISO 4014 M24 x 70-10.9

116752	5,050
--------	-------

Wall Bracing Shoe CB M24

To prevent tipping over due to wind loads with Tension Belt or Tie Rod DW 15 and to stabilise the finishing platform. To be mounted on the Climbing Anchor M24 embedded in the concrete.

Complete with

2 pc. 104031 Fitting Pin \varnothing 21 x 120

2 pc. 018060 Cotter Pin 4/1, galv.

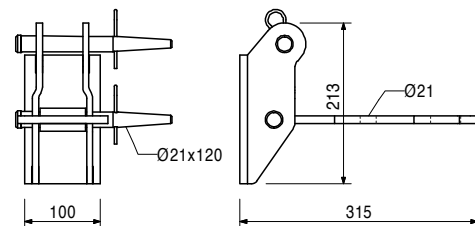
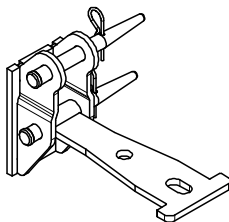

Accessories

026430	0,334
--------	-------

Bolt ISO 4014 M24 x 70-10.9

Item no. Weight kg

026430 0,334

Bolt ISO 4014 M24 x 70-10.9, glav.

High-strength bolt for anchoring climbing systems.

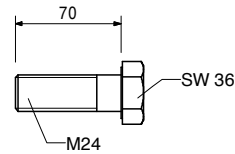
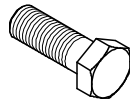

027180 1,760

Ratchet Lever SW 19

For operation of the adjusting unit and of the carriage with drive shaft SW 19.

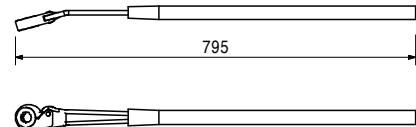
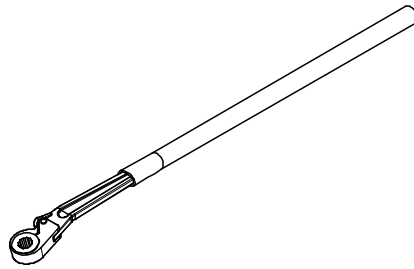

Accessories

027200 0,100

Insert Socket SW 19

031480 2,460

Socket Wrench SW 36, chrome-plated

For various purposes.

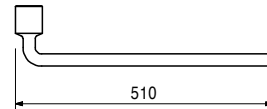
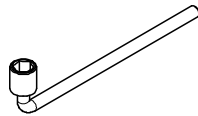

027212 0,445

Allen Key SW 14, long

Fits to PERI Anchor Positioning Studs and Allen Key Bolts M16.

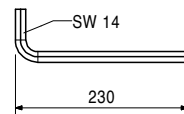
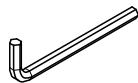

072180 0,560

Ratchet Wrench 1/2"

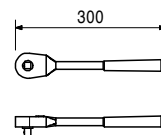
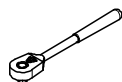

Item no.	Weight kg
029620	0,075

Socket SW 19-1/2"

Fits to Hex. Bolts M12 or Height Adjusting Unit SW 19.

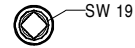

118638	8,790
--------	-------

Arch. Anchor Sleeve M24-150/2

Centre piece of the double-sided architectural concrete anchoring CB. Anchor Tie DW 15 is passing through.
Plate size 150 mm.

Note

Order item!
Specify wall thickness D.
Seperate design information on request.

Technical Data

Min. D = 200 mm.
Max. D = 400 mm.
L = D - 130 mm.

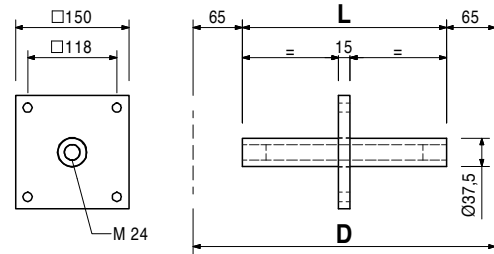
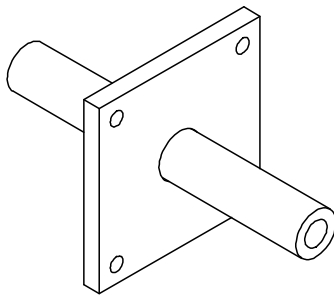

126793	3,190
126795	3,490

Arch. Anchors Sleeve M24-150/2

Arch. Anchor Sleeve M24-150/2, D = 25

Arch. Anchor Sleeve M24-150/2, D = 30

Note

Seperate design information on request.

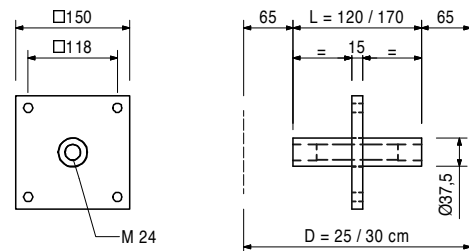
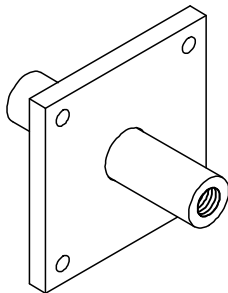

Item no.	Weight kg
116279	7,530

Arch. Anchor Sleeve M24-120/2

Centre piece of the double-sided architectural concrete anchoring CB. Anchor Tie DW 15 is passing through.
Plate size 120 mm.

Note

Order item!
Specify wall thickness D.
Separate design information on request.

Technical Data

Min. D = 200 mm.
Max. D = 400 mm.
L = D - 130 mm.

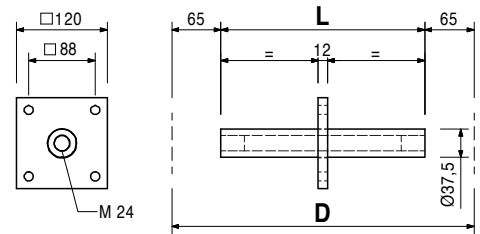
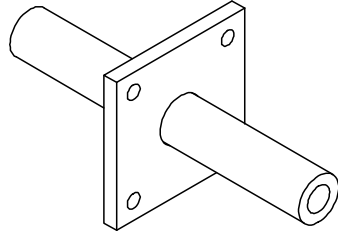

116385	0,189
--------	-------

Arch. Leading Cone M24/DW 26

Leading cone for single- or double-sided architectural concrete anchorings CB.
Creates a recess for Arch. Mounting Cone M24 and Concrete Cone DK 58/52.

Note

Plastic version.

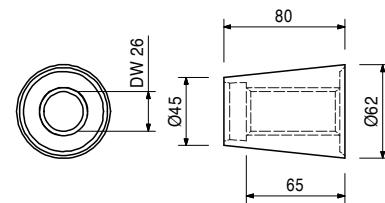
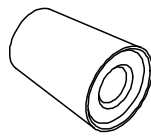

Accessories

115499	0,878
--------	-------

Leading Cone Screw DW 26

125512	0,966
--------	-------

Arch. Leading Cone M24/DW 26 Steel

Leading cone for single- or double-sided architectural anchorings CB.
Creates a recess for Arch. Mounting Cone M24 and concrete cone DK 58/52.
Can also be used as shear cone for anchoring FB or KG Brackets.

Note

Steel version.
Separate design information on request.

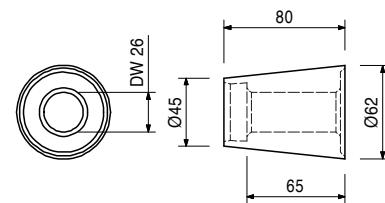
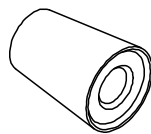

Accessories

115499	0,878
--------	-------

Leading Cone Screw DW 26

Item no.	Weight kg
125963	3,100

Arch. Anchor Sleeve M24-150/1

Anchor sleeve for single-sided architectural concrete anchoring CB.
Anchor Tie DW 15 is passing through.
Plate size 150 mm.

Note

Separate design information on request.

Technical Data

Fixed embedment depth 170 mm.
Min. wall thickness 200 mm.

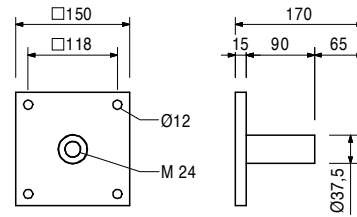
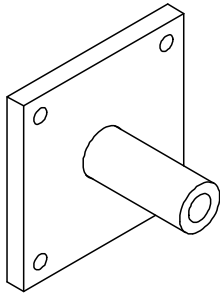

Accessories

065027	0,359
065033	0,010

Spacer Tube rough DR 22, l = 2.00 m
Cone DR 22

114606	1,630
--------	-------

Arch. Mounting Cone M24

For anchoring climbing systems compatible with Mounting Ring M24.
Fixation to Arch. Anchor Sleeves M24-120/2, M24-150/2 or M24-150/1.

Note

Separate design information on request.

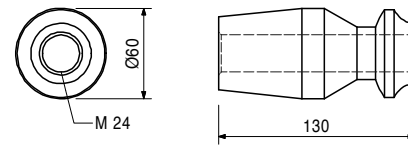
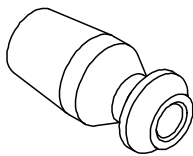

Accessories

057138	0,665
--------	-------

Hex. Bolt ISO 4014 M24 x 160-8.8, galv.

057138	0,665
--------	-------

Hex. Bolt ISO 4014 M24 x 160-8.8, galv.

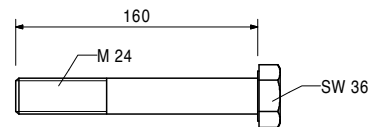
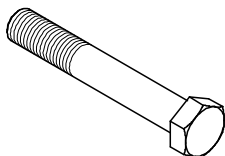

031642	0,167
--------	-------

DK Concrete Cone DW 15-58/30

For closing anchor points with DK Sealing Cone DW 15/35.

Note

Delivery unit 50 pieces.

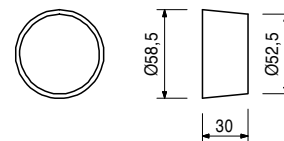

Item no. Weight kg

031643 0,241

DK Concrete Cone UNI 58/52

For closing anchor points with DK Sealing Cone DW 15/55, DW 20/55, DW 26/55 and SK Anchor Cone DW 15.

Note

Delivery unit 50 pieces.

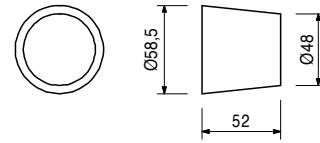
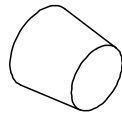

031641 0,260

DK Concrete Cone Architec. DW 15-58/52

For closing anchor points with DK Sealing Cone DW 15/55 with corresponding architectural requirements.

Note

Delivery unit 50 pieces.

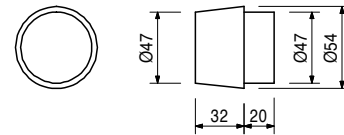
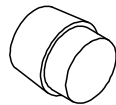

108136 5,000

Glue for Concrete Cones-2, 5-kg-Set

For bonding PERI concrete cones.

Note

See Safety Data sheet!

Consisting of:

6 x Component A,

6 x Component B

2 x Stirring Container,

3 x Stirring Staff

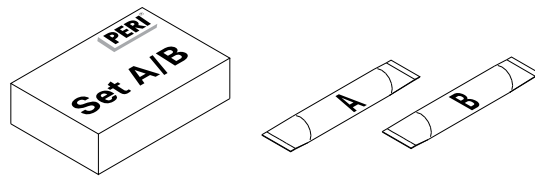

065027 0,359

Spacer Tube rough DR 22, l = 2.00 m

Plastic Spacer Tube for DW 15, B 15.

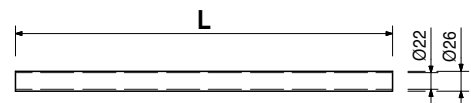
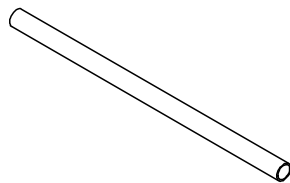

065033 0,010

Cone DR 22

Plastic. Suitable for Spacer Tube DR 22.

Note

Delivery unit 500 pieces.

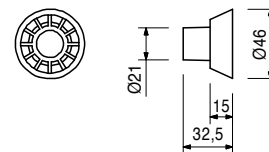

Item no.	Weight kg
065036	0,002

Plug DR 22
Plastic. Suitable for Spacer Tube DR 22.

Note
Delivery unit 1000 pieces.

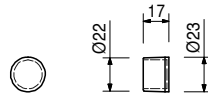

115499	0,878
--------	-------

Leading Cone Screw DW 26
For recovering the Arch. Leading Cone M24/DW 26.

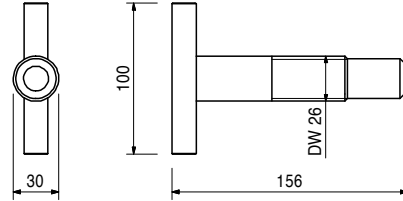
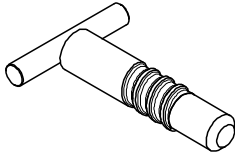

031480	2,460
--------	-------

Socket Wrench SW 36, chrome-plated
For various purposes.

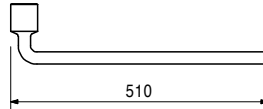
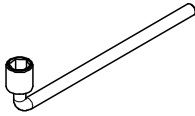

031644	0,588
--------	-------

DK Tong for Concrete Cone 58
For holding DK, SK or KK Concrete Cones with corresponding diameter during installation.

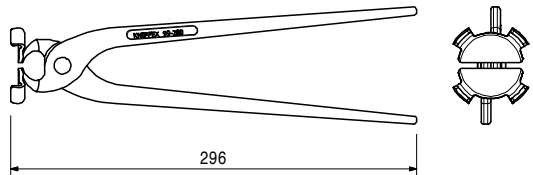
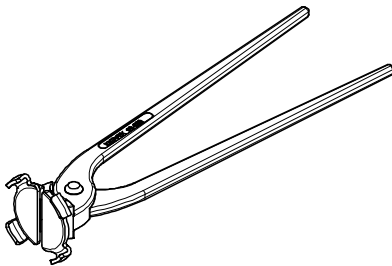

101995	1,020
--------	-------

Concrete Cone Gauge
Installation of concrete cones flush with the surface.

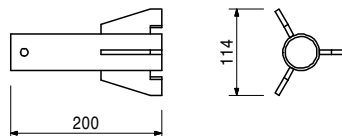
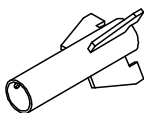

BR Shaft Platform

Item no.	Weight kg
020320	21,800
020510	27,400
020310	32,800
020520	38,600

- Platform Beam BR**
- Platform Beam BR U100**
- Platform Beam BR U120**
- Platform Beam BR U140**
- Platform Beam BR U160**

As cross beam for shaft platforms. The specified item no. is for the platform beams only (2 pieces). Required accessories are to be ordered separately.

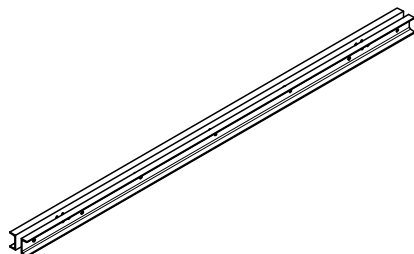

Note
Structural calculations are required. Information on longitudinal separation corresponding to item numbers and a separate design information on request.

Technical Data
Double U-profile corresponding to DIN 1026-1, S235

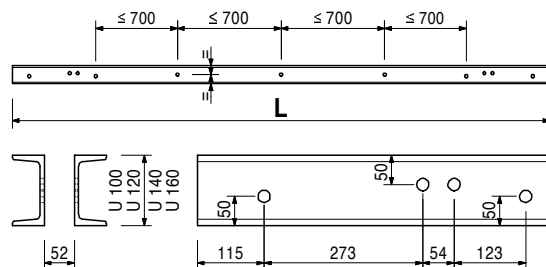

Accessories

020620	0,561
127834	2,210
020330	12,100
020600	6,870

- Spacer for Platform Beam BR**
- Crane Eye BR-2 2.5 t, galv.**
- Folding Bearing Plate 25**
- Gravity Pivot Plate BR**

020620	0,561
--------	-------

Spacer for Platform Beam BR
For Platform Beam BR or Steel Walers SRU.

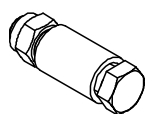

Complete with
1 pc. 710226 Bolt ISO 4014 M20 x 90-8.8, galv.
1 pc. 781053 Nut ISO 7042 M20-8, galv.

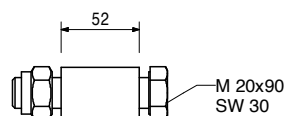

127834	2,210
--------	-------

Crane Eye BR-2 2.5 t, galv.
As attachment point for moving climbing systems or Platform Beam BR.

Note
Follow Instructions for Use!

Technical Data
Permissible load-bearing point capacity 2.5 t.

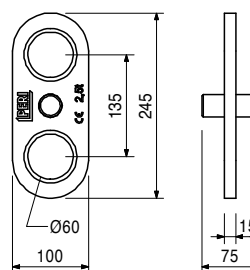

Accessories

020620	0,561
--------	-------

Spacer for Platform Beam BR

Item no.	Weight kg
020600	6,740

Gravity Pivot Plate BR

For supporting Platform Beam BR in wall box-outs.
2 pieces per platform beam.

Complete with

1 pc. 710226 Bolt ISO 4014 M20 x 90-8.8, galv.
1 pc. 781053 Nut ISO 7042 M20-8, galv.

Note

Seperate design information on request.

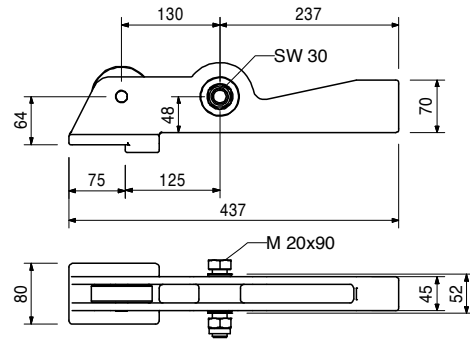
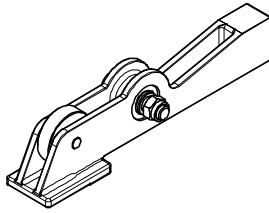

Accessories

108162	1,800
--------	-------

Bearing Box BR

108162	1,800
--------	-------

Bearing Box BR

For creating wall box-outs for mounting with the gravity pivot plate.

Note

Reusable.

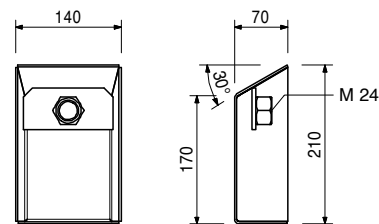
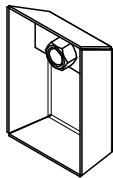

Accessories

029270	0,331
--------	-------

Advancing Bolt M24, galv.

020330	12,100
--------	--------

Folding Bearing Plate 25

For supporting Platform Beam BR with Anchor System M24. 2 pieces per platform beam.

Note

Seperate design information on request.

Technical Data

Permissible load 25.0 kN.

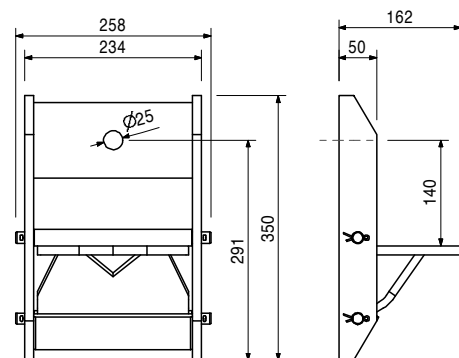
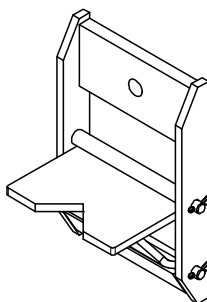

Accessories

026430	0,334
--------	-------

Bolt ISO 4014 M24 x 70-10.9

Item no. Weight kg

026430 0,334

Bolt ISO 4014 M24 x 70-10.9, galv.
High-strength bolt for anchoring climbing systems.

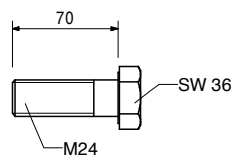
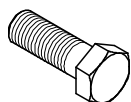

026230 1,010

Anchor Sleeve M24
To anchor platform systems.

Note
Separate design information on request.

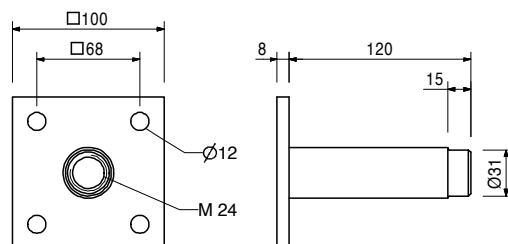
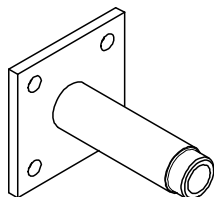

Accessories

026240 0,026

Cone PP Ø 31/26, c = 25

026250 0,005

Plug Ø 26 mm

116233 0,116

Cone FRC Ø 32/52, c = 40

026420 0,123

Anchor Positioning Stud M24, galv.

116234 0,033

Plug FRC Ø 32 mm

115150 0,200

Anchor Positioning Stud M24 x 65, galv.

026240 0,026

Cone PP Ø 31/26, c = 25
Resulting in a concrete cover of 25 mm in combination with Anchor Sleeve M24. Made of polypropylene.

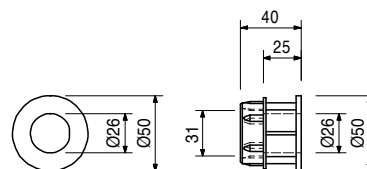

026250 0,005

Plug Ø 26 mm
For closing Cone PP Ø 31 for Anchor Sleeve M24. Made of polypropylene.

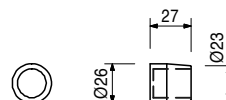

Item no.	Weight kg
114158	1,030

Screw-On Cone-2 M24/DW 20, galv.
Anchor system M24.
For anchoring climbing systems.

Note
Separate design information on request.

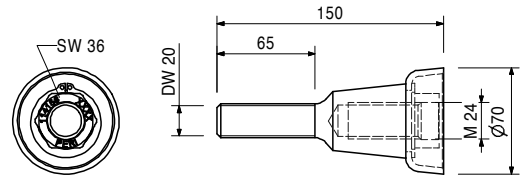
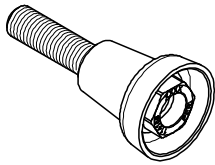

Accessories

030860	0,801
--------	-------

Threaded Anchor Plate DW 20

030860	0,801
--------	-------

Threaded Anchor Plate DW 20
For use with Tie Rod DW 20, B 20 or Screw-On Cone-2 M24/DW 20. For anchoring in concrete.

Note
Lost anchor part.

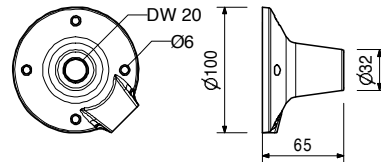
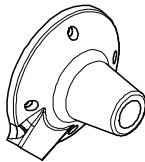

029270	0,331
--------	-------

Advancing Bolt M24, galv.
For fixing the M24 anchor system if the plywood formlining is drilled through.

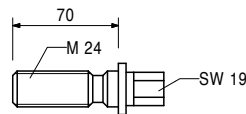
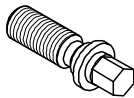

Accessories

029280	0,196
--------	-------

Anchor Positioning Plate M24, galv.

029280	0,196
--------	-------

Anchor Positioning Plate M24, galv.
For fixing the M24 anchor system if the plywood formlining is drilled through.

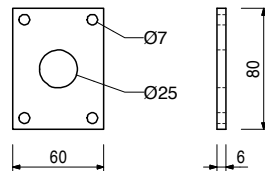
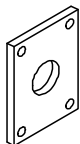

Accessories

029440	0,005
--------	-------

Lag Screw DIN 571 6 x 20, galv.

BR Shaft Platform

Item no.	Weight kg	
029440	0,005	Lag Screw DIN 571 6 x 20, galv.

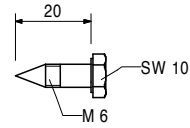

026420	0,123	Anchor Positioning Stud M24, galv. For fixing the M24 anchor system if the plywood formlining is not drilled through.	Note Allen Key SW 14.
--------	-------	---	---------------------------------

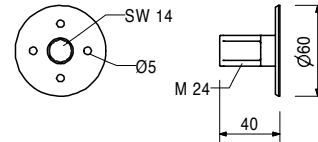

Accessories

027212	0,445	Allen Key SW 14, long
710312	0,005	Nail 3 x 80

024070	0,691	Hook Strap HB 24-100/120, galv. For fixing GT 24 Girders to Steel Walers SRZ, SRU and BR: U100 – U120.
--------	-------	--

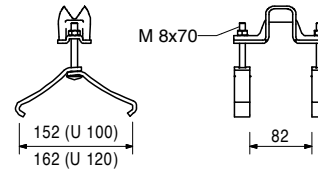
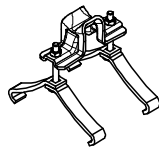

024860	0,616	Hook Strap HB 24 QB 150, galv. For fixing GT 24 Girders independant from girder node and timber beams to Steel Walers SRZ, SRU and BR: U100 – U120.
--------	-------	---

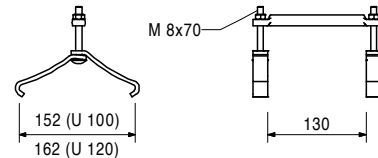
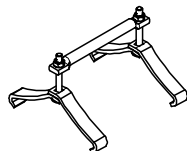

Item no.	Weight kg
024080	0,735

Hook Strap HB 24-140/160, galv.
 For fixing GT 24 Girders to Steel Walers SRZ, SRU and BR: U140 – U160.

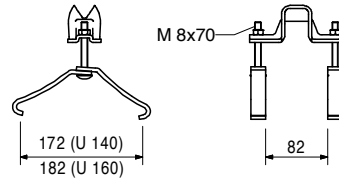
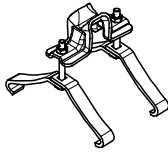

115544	0,837
--------	-------

Hook Strap Uni HBU 14-17
 For fixing timbers 80 x 160 mm to Steel Walers SRZ, SRU and BR: U100 – U140.

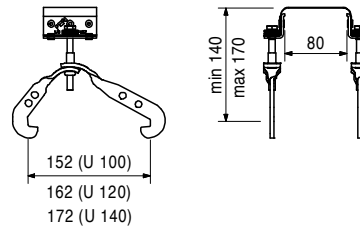
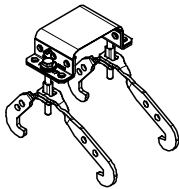

Accessories

024540	0,005
--------	-------

TSS-Torx 6 x 40, galv.

104931	0,865
--------	-------

Hook Strap Uni HBU 20-24
 For fixing GT 24 Girders or VT 20 Girders to Steel Walers SRZ, SRU and BR: U100 – U140.

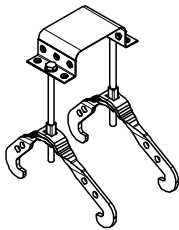

Note
 The girders can be mounted at right-angles or diagonally to the steel walers and also outside of the nodes.

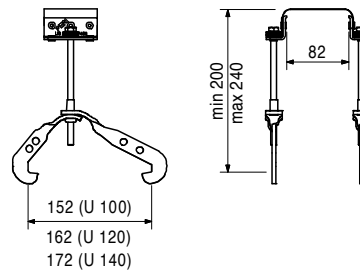

Accessories

024540	0,005
--------	-------

TSS-Torx 6 x 40, galv.

Item no.	Weight kg
103845	0,893

Hook Strap Uni HBU 24-28

For fixing GT 24 Girders to Steel Walers SRZ, SRU and BR: U100 – U140.

Note

The girders can be mounted at right-angles or diagonally to the steel walers and also outside of the nodes.

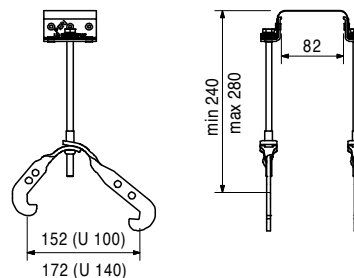
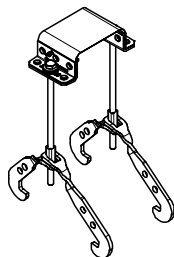

Accessories

024540	0,005
--------	-------

TSS-Torx 6 x 40, galv.

111806	0,921
--------	-------

Hook Strap Uni HBU 24-26 U200

For assembling the GT 24 Girder on the Climbing Rails RCS and LPS or on Steel Walers BR: U140 – U160.

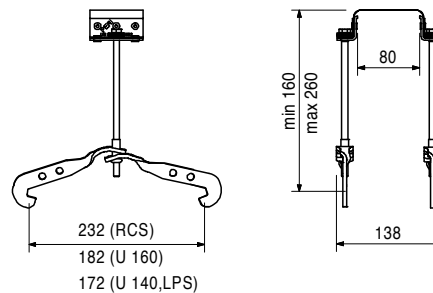
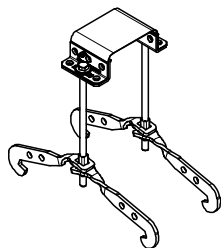

Accessories

024540	0,005
--------	-------

TSS-Torx 6 x 40, galv.

030370	1,660
--------	-------

Wingnut Pivot Plate DW 15, galv.

For anchoring with Tie Rod DW 15 and B 15. With pivoting captive nut. Maximum angle of tilting 8°.

Note

Wrench size SW 27.

Technical Data

Permissible load 90 kN.

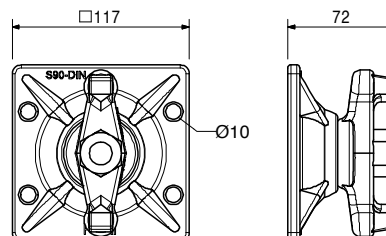
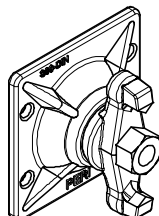

Item no.	Weight kg
030070	0,222

Hex. Nut DW 15 SW 30/50, galv.
For anchoring with Tie Rod DW 15 and B 15.

Technical Data
Permissible load 90 kN.

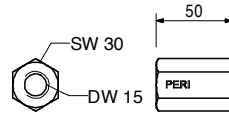

115378	1,080
--------	-------

Eye Nut RCS DW 15
As an articulated connection to the Climbing Rail RCS, Steel Water SRU for bracing with DW 15.

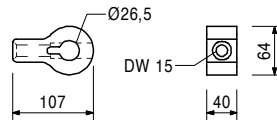

Accessories

104031	0,462
018060	0,030
111567	0,729
022230	0,033

Fitting Pin Ø 21 x 120
Cotter Pin 4/1, galv.
Fitting Pin Ø 26 x 120
Cotter Pin 5/1, galv.

030030	1,440
030050	0,000

Tie Rod DW 15
Tie Rod DW 15, Spec. Length
Cutting Cost Tie Rod DW 15, B 15

Note
Non-weldable! Take official approval into consideration!

Technical Data
Permissible tension force 90 kN.

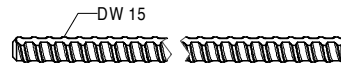
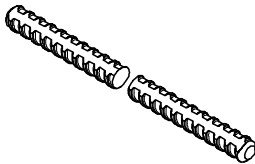

030740	1,550
030050	0,000

Tie Rod B 15
Tie Rod B 15, Spec. Length
Cutting Cost Tie Rod DW 15, B 15

Note
Weldable! Take official approval into consideration!

Technical Data
Permissible tension force 82 kN.

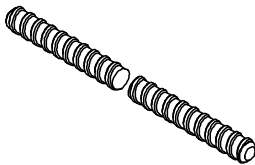

BR Shaft Platform



Item no.	Weight kg	
026412	7,100	Scaff. Tube Steel Ø 48.3 x 3.2, l = 2.0 m

L
2000

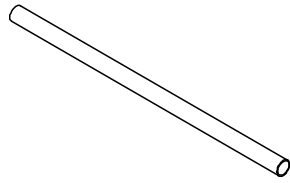

		Steel Walers Universal SRU	L
103868	18,100	Steel Waler Universal SRU U120, l = 0.72 m	722
103871	24,200	Steel Waler Universal SRU U120, l = 0.97 m	972
103874	30,900	Steel Waler Universal SRU U120, l = 1.22 m	1222
103877	38,100	Steel Waler Universal SRU U120, l = 1.47 m	1472
103886	44,700	Steel Waler Universal SRU U120, l = 1.72 m	1722
103889	52,000	Steel Waler Universal SRU U120, l = 1.97 m	1972
103898	58,600	Steel Waler Universal SRU U120, l = 2.22 m	2222
103892	65,600	Steel Waler Universal SRU U120, l = 2.47 m	2472
103929	72,000	Steel Waler Universal SRU U120, l = 2.72 m	2722
103903	81,000	Steel Waler Universal SRU U120, l = 2.97 m	2972
103906	92,600	Steel Waler Universal SRU U120, l = 3.47 m	3472
103915	106,000	Steel Waler Universal SRU U120, l = 3.97 m	3972
103918	119,000	Steel Waler Universal SRU U120, l = 4.47 m	4472
103922	135,000	Steel Waler Universal SRU U120, l = 4.97 m	4972
103925	146,000	Steel Waler Universal SRU U120, l = 5.47 m	5472
103928	159,000	Steel Waler Universal SRU U120, l = 5.97 m	5972

Universal steel waler profile U120 used as waling for girder wall formwork and for diverse special applications. With adjustable spacers.

Note

Permissible load: see PERI Design Tables.

Technical Data

U120: $W_y = 121.4 \text{ cm}^3$, $I_y = 728 \text{ cm}^4$.

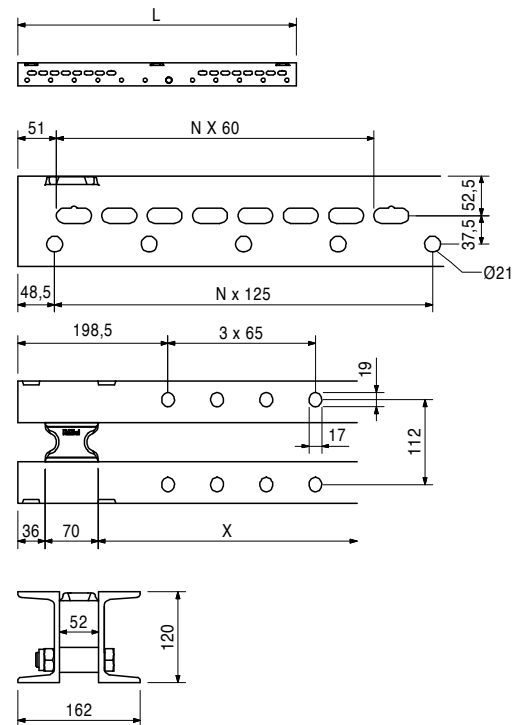
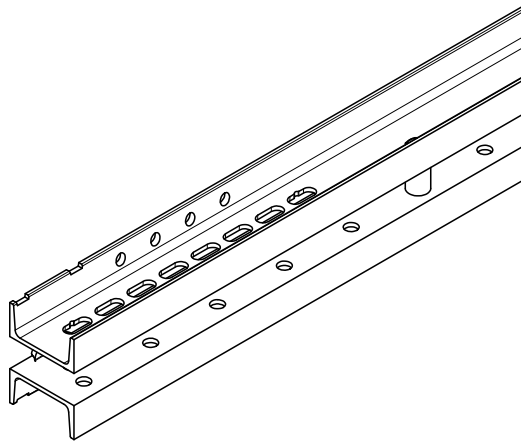

Ladder Access for Climbing Systems

Item no.	Weight kg
126431	12,300

Hatch 55 x 60-2, foldable

Self-closing hatch for ladder access. Clear opening approx. 55 x 60 cm. Ladder fixation with bolts or by hanging up.

Complete with

1 pc. 126785 Hatch Hinge RCS
 12 pc. 108647 Rivet DIN 7337- A5 x 20
 2 pc. 022230 Cotter Pin 5/1, galv.

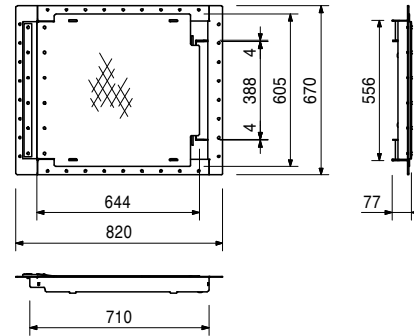
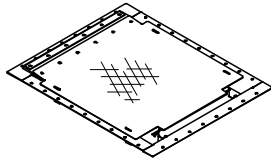

Accessories

710224	0,047
710381	0,017

Bolt ISO 4017 M12 x 40-8.8, galv.
Nut ISO 7042 M12-8, galv.

110608	15,600
--------	--------

Hatch 55 x 60, foldable

Self-closing hatch for ladder access. Clear opening approx. 55 x 60 cm. Ladder fixation with bolts.

Complete with

1 pc. 110529 Hinging Plate left, galv.
 1 pc. 110535 Hinging Plate right, galv.
 8 pc. 721412 Rivet DIN 7337 - A4,8 x 12

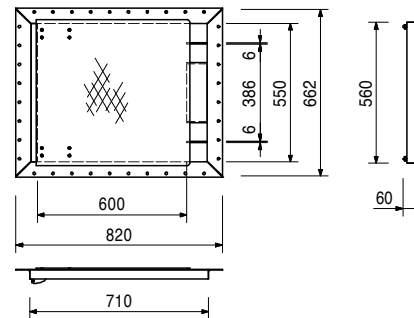
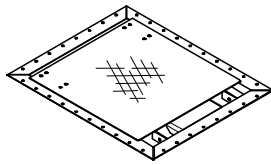

Accessories

710224	0,047
710381	0,017

Bolt ISO 4017 M12 x 40-8.8, galv.
Nut ISO 7042 M12-8, galv.

051430	37,900
--------	--------

Sliding Hatch Cover

Non self-closing hatch for ladder access. Clear opening approx. 73 x 55 cm. Ladder fixation with bolts.

Complete with

4 pc. 710266 Bolt ISO 4017 M12 x 25-8.8, galv.
 4 pc. 710381 Nut ISO 7042 M12-8, galv.

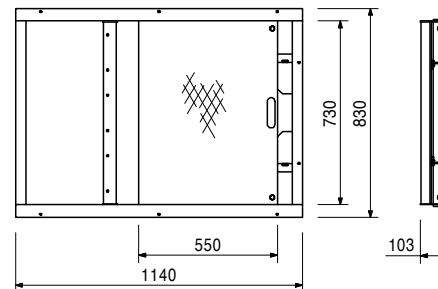
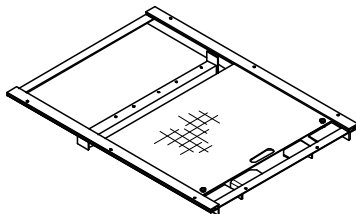

Ladder Access for Climbing Systems



Item no.	Weight kg
051410	11,700

Ladder 180/6, galv.
As access for PERI formwork systems.

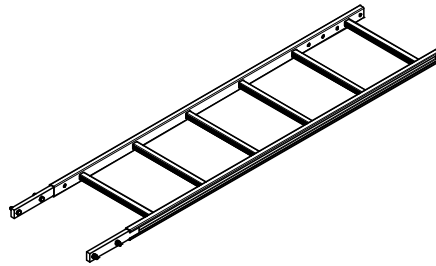

Complete with
4 pc. 710224 Bolt ISO 4017 M12 x 40-8.8, galv.
4 pc. 710381 Nut ISO 7042 M12-8, galv.

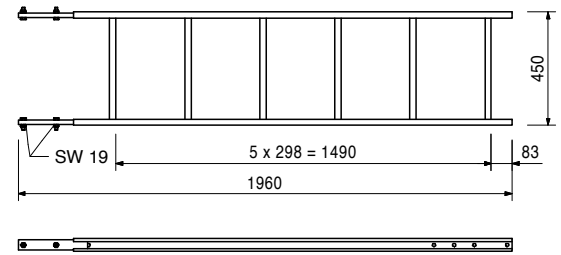

051420	12,800
--------	--------

Ladder 220/6
As access for PERI formwork systems.

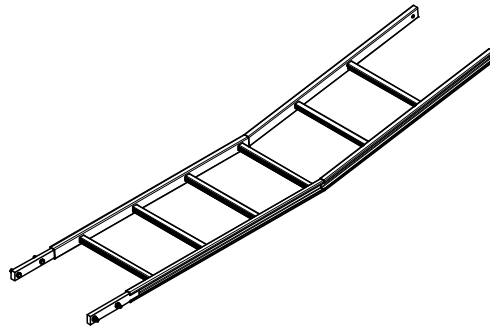

Complete with
4 pc. 710224 Bolt ISO 4017 M12 x 40-8.8, galv.
4 pc. 710381 Nut ISO 7042 M12-8, galv.

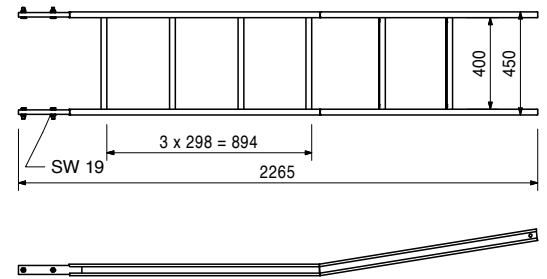

103724	10,400
--------	--------

End Ladder 180/2, galv.
As access for PERI formwork systems.

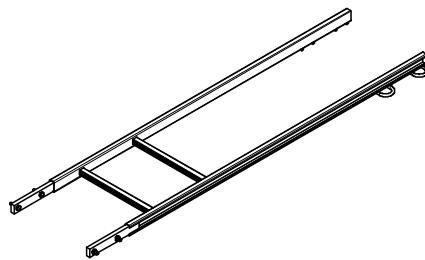

Complete with
4 pc. 710224 Bolt ISO 4017 M12 x 40-8.8, galv.
4 pc. 710381 Nut ISO 7042 M12-8, galv.

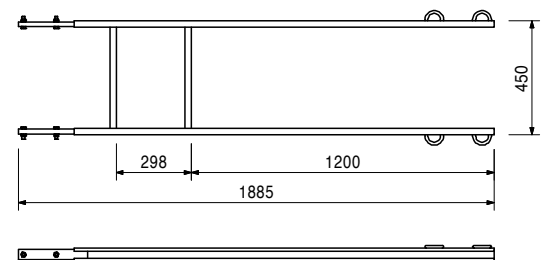

109105	5,070
--------	-------

Ladder Base 30 adjustable, galv.
For horizontal fixing of ladders on the platform decking.

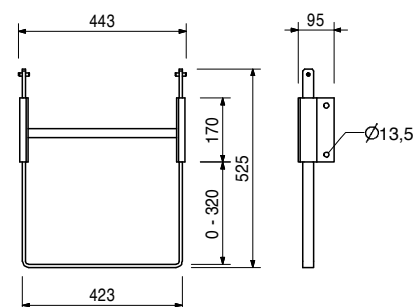
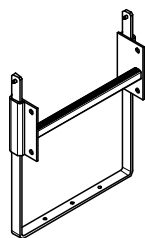

Ladder Access for Climbing Systems

Item no.	Weight kg
051460	2,180

Ladder Base, galv.

As bottom ladder connection and for securing ladders against sliding on the scaffold decks.

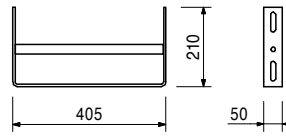
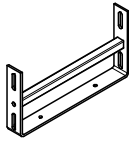

103718	0,684
--------	-------

Ladder Hook, galv.

For adjusting the bottom ladder. Always use in pairs.



Complete with

2 pc. 710266 Bolt ISO 4017 M12 x 25-8.8, galv.
2 pc. 710381 Nut ISO 7042 M12-8, galv.

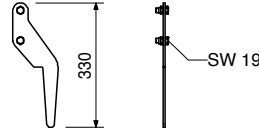

104132	15,600
051450	25,200

Ladder Safety Cages, galv.

Ladder Safety Cage 75, galv.

Ladder Safety Cage 150, galv.

Ladder safety cage for PERI access ladders.

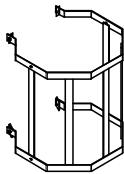

Complete with

4 pc. 710266 Bolt ISO 4017 M12 x 25-8.8, galv.
4 pc. 701763 Clamping Plate FI 25 x 10 x 90

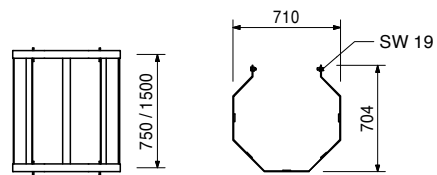

111165	6,080
--------	-------

Ladder Connector VARIO, adjustable

For connecting ladders to Steel Walers SRZ and SRU, Profile U100 - U120.

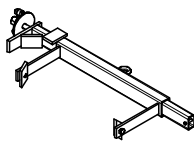

Complete with

2 pc. 710266 Bolt ISO 4017 M12 x 25-8.8, galv.
2 pc. 701763 Clamping Plate FI 25 x 10 x 90

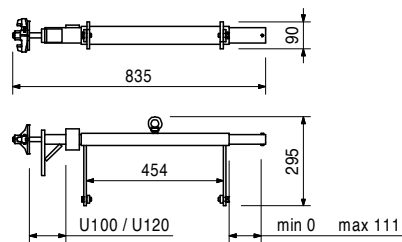

PERI International

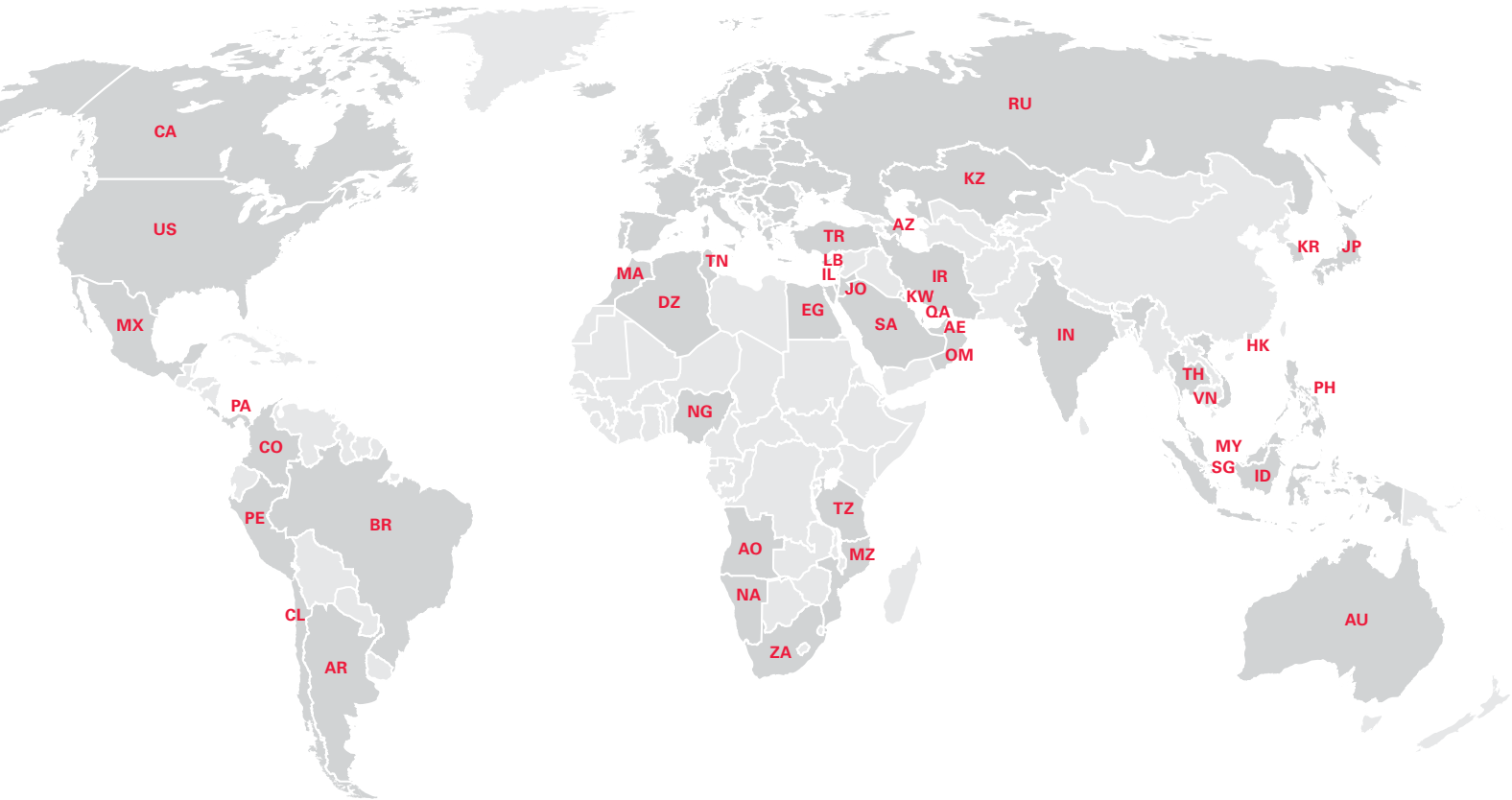

North America

- CA** Canada
PERI Formwork Systems, Inc.
www.peri.ca
- MX** Mexico
PERI Cimbras y Andamios, S.A. de C.V.
www.peri.com.mx
- PA** Panama
PERI Panama Inc.
www.peri.com.pa
- US** USA
PERI Formwork Systems, Inc.
www.peri-usa.com

South America

- AR** Argentina
PERI S.A.
www.peri.com.ar
- BR** Brazil
PERI Formas e Escoramentos Ltda.
www.peribrasil.com.br
- CL** Chile
PERI Chile Ltda.
www.peri.cl
- CO** Colombia
PERI S.A.S.
www.peri.com.co
- PE** Peru
PERI Peruana S.A.C.
www.peri.com.pe

Africa

- AO** Angola
Pericofragens, Lda.
www.peri.pt
- DZ** Algeria
S.A.R.L. PERI
www.peri.dz
- EG** Egypt
Egypt Branch Office
www.peri.com.eg
- MA** Morocco
PERI S.A.
www.peri.ma
- MZ** Mozambique
PERI (Pty.) Ltd.
www.peri.co.mz
- NA** Namibia
PERI (Pty.) Ltd.
www.peri.na
- NG** Nigeria
PERI Nigeria Ltd.
www.peri.ng
- TN** Tunisia
PERI S.A.U.
www.peri.es
- TZ** Tanzania
PERI Formwork and Scaffolding Ltd
www.peri.co.tz
- ZA** South Africa
PERI Formwork Scaffolding (Pty) Ltd
www.peri.co.za

Asia

- AE** United Arab Emirates
PERI (L.L.C.)
www.peri.ae
- AZ** Azerbaijan
PERI Representative Office
www.peri.com.tr
- HK** Hong Kong
PERI (Hong Kong) Limited
www.perihk.com
- ID** Indonesia
PT Beton Perkasa Wijaksana
www.betonperkasa.com
- IL** Israel
PERI F.E. Ltd.
www.peri.co.il
- IN** India
PERI (India) Pvt Ltd
www.peri.in
- IR** Iran
PERI Pars. Ltd.
www.peri.ir
- JO** Jordan
PERI GmbH – Jordan
www.peri.com
- JP** Japan
PERI Japan K.K.
www.peri.co.jp
- KR** Korea
PERI (Korea) Ltd.
www.perikorea.com
- KW** Kuwait
PERI Kuwait W.L.L.
www.peri.com.kw
- KZ** Kazakhstan
TOO PERI Kazakhstan
www.peri.kz
- LB** Lebanon
PERI Lebanon Sarl
lebanon@peri.de
- MY** Malaysia
PERI Formwork Malaysia Sdn. Bhd.
www.perimalaysia.com
- OM** Oman
PERI (L.L.C.)
www.peri.ae
- PH** Philippines
PERI-Asia Philippines, INC.
www.peri.com.ph
- QA** Qatar
PERI Qatar LLC
www.peri.qa
- SA** Saudi Arabia
PERI Saudi Arabia Ltd.
www.peri.com.sa
- SG** Singapore
PERI Asia Pte Ltd
www.periasia.com
- TH** Thailand
Peri (Thailand) Co., Ltd.
www.peri.co.th
- TR** Turkey
PERI Kalıp ve İskeleleri
www.peri.com.tr
- VN** Vietnam
PERI ASIA PTE LTD
www.peri.com.vn



PERI

PERI GmbH Formwork Scaffolding Engineering

Rudolf-Diesel-Strasse 19
89264 Weissenhorn
Germany
Tel. +49 (0)7309.950-0
Fax +49 (0)7309.951-0
info@peri.com
www.peri.com

Oceania

AU Australia
PERI Australia Pty. Ltd.
www.periaus.com.au

DK Denmark
PERI Danmark A/S
www.peri.dk

IT Italy
PERI S.r.l.
www.peri.it

SE Sweden
PERI Sverige AB
www.peri.se

Europe

EE Estonia
PERI AS
www.peri.ee

LT Lithuania
PERI UAB
www.peri.lt

SI Slovenia
PERI oplate i skele d.o.o
www.peri.com.hr

AL Albania
PERI Kalıp ve İskeleleri
www.peri.com.tr

ES Spain
PERI S.A.U.
www.peri.es

LU Luxembourg
N.V. PERI S.A.
www.peri.lu

SK Slovakia
PERI spol. s. r.o.
www.peri.sk

AT Austria
PERI Ges.mBH
www.peri.at

FI Finland
PERI Suomi Ltd. Oy
www.perisuomi.fi

LV Latvia
PERI SIA
www.peri-latvija.lv

UA Ukraine
TOW PERI
www.peri.ua

BA Bosnia and Herzegovina
PERI oplate i skele d.o.o
www.peri.com.hr

FR France
PERI S.A.S.
www.peri.fr

NL Netherlands
PERI b.v.
www.peri.nl

BE Belgium
PERI N.V.
www.peri.be

GB United Kingdom
PERI Ltd.
www.peri.ltd.uk

NO Norway
PERI Norge AS
www.peri.no

BG Bulgaria
PERI Bulgaria EOOD
www.peri.bg

GR Greece
PERI Hellas Ltd.
www.perihellas.gr

PL Poland
PERI Polska Sp. z o.o.
www.peri.com.pl

BY Belorussia
IOOO PERI
www.peri.by

HR Croatia
PERI oplate i skele d.o.o.
www.peri.com.hr

PT Portugal
Pericofragens Lda.
www.peri.pt

CH Switzerland
PERI AG
www.peri.ch

HU Hungary
PERI Kft.
www.peri.hu

RO Romania
PERI România SRL
www.peri.ro

CZ Czech Republic
PERI spol. s r.o.
www.peri.cz

IR Ireland
Siteserv Access & Formwork
www.siteservaccess.ie

RS Serbia
PERI oplate d.o.o.
www.peri.rs

DE Germany
PERI GmbH
www.peri.de

IS Iceland
Armar ehf.
www.armor.is

RU Russia
OOO PERI
www.peri.ru

**The optimal System
for every Project and
every Requirement**



Wall Formwork



Column Formwork



Slab Formwork



Climbing Systems



Bridge Formwork



Tunnel Formwork



Shoring Systems



Construction Scaffold



Facade Scaffold



Industrial Scaffold



Access



Protection Scaffold



Safety Systems



**System-Independent
Accessories**



Services



PERI GmbH
Formwork Scaffolding Engineering
 Rudolf-Diesel-Strasse 19
 89264 Weissenhorn
 Germany
 Tel. +49 (0)7309.950-0
 Fax +49 (0)7309.951-0
 info@peri.com
 www.peri.com

