

# PERI Rental Criteria

## DOMINO



### Contact

**PERI GmbH**  
**Formwork Scaffolding**  
**Engineering**

P.O. Box 1264  
 89264 Weißenhorn; Germany  
 Phone +49 (0) 7309.950-0  
 Fax +49 (0) 7309.951-0  
 rental-criteria@peri.de

Content	Page	Changes	Date   Initial	Page
Frame	2	New version	10/2015   fw	
Articulated corner	12			
Wall thickness compensation	15			
Shaft element	18			
External corner	22			
Dismantling panel	24			
Accessories	28			
Glossary	35			

# PERI Rental Criteria

## DOMINO



Frame steel	No.	Name	Article number
-------------	-----	------	----------------

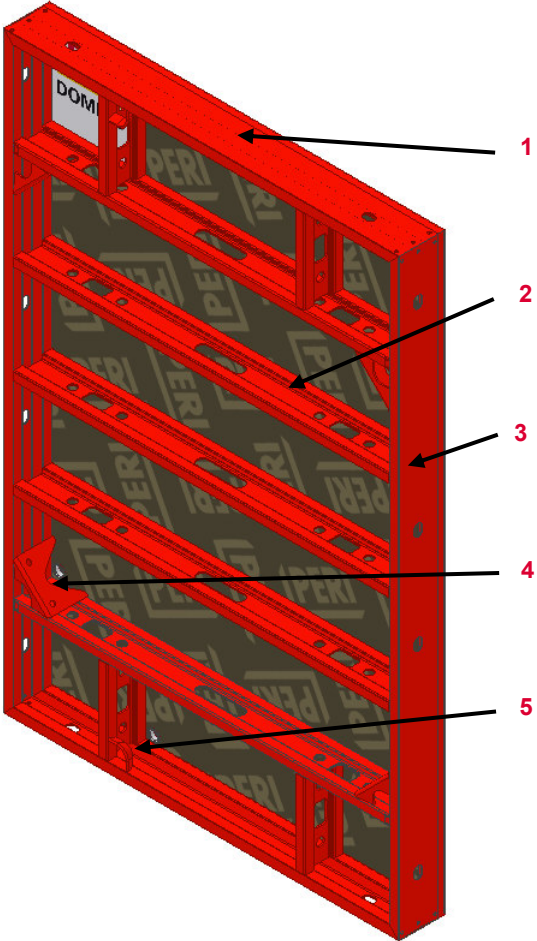

1	Front profile	
2	Brace	
3	Length profile	
4	Tie pocket	108556
5	Tie plate	740473

# PERI Rental Criteria

## DOMINO



Article	Article number
Element D 250x100	066020
Element D 250x75	066022
Element D 250x50	066025
Element D 250x35	125501
Element D 250x25	066026
Multi Panel DM 250x75	066024
Element D 150x100	124498
Element D 150x75	124504
Element D 150x50	124510
Element D 150x35	124517
Element D 150x25	124523
Multi Panel DM 150x75	124538

Article	Article number
Element D 125x100	066040
Element D 125x75	066041
Element D 125x50	066043
Element D 125x35	125494
Element D 125x25	066044
Multi Panel DM125x75	066042
Element D 75x25	066064
Element D 75x35	125486
Element D 75x50	066063
Element D 75x75	066061
Element D 75x100	066060
Multi Panel DM 75x75	066062

# PERI Rental Criteria

## DOMINO



### Frame Alu

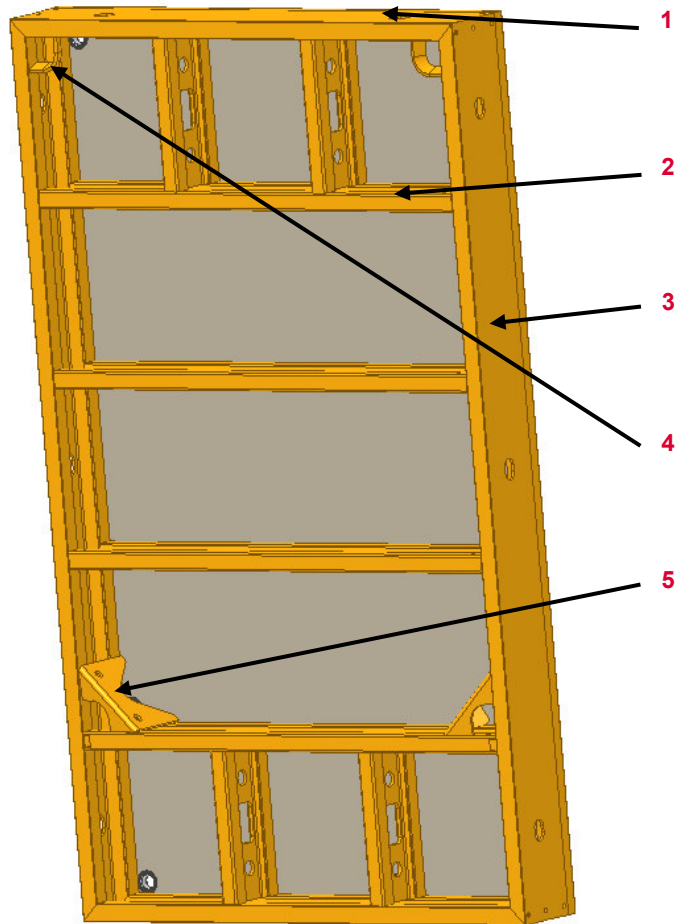







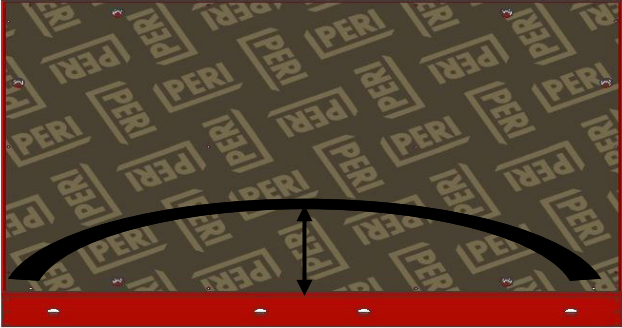

No.	Name	Article number
1	Front profile	
2	Brace	
3	Front profile	
4	Anchor plate Alu	740474
5	Tie pocket Alu	108567

Article	Article number
DA 125x 100	066050
DA 125x 75	066051
DA 250x 100	066021
DA 250x 75	066023

# PERI Rental Criteria

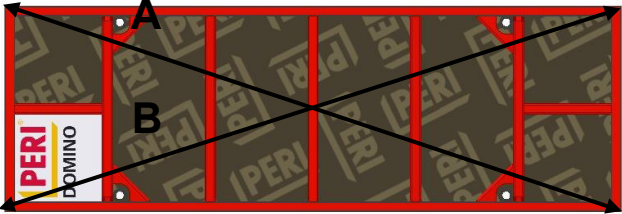
## DOMINO













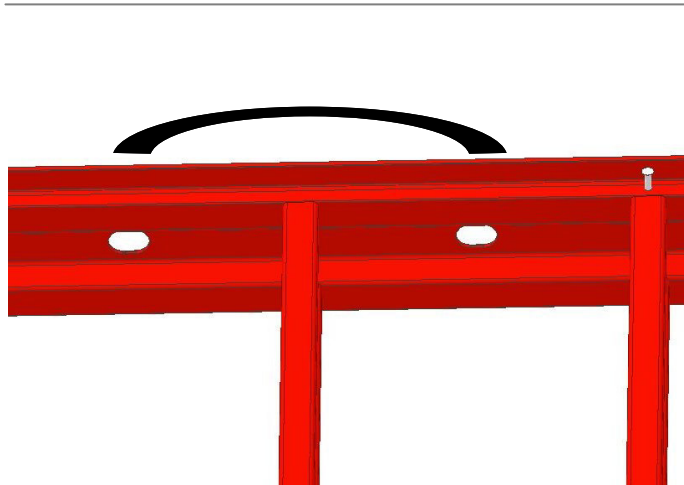

Frame	Description	Instruction	Billing Condition	Tyoe
	<p><b>24.01 Element bent</b></p> <ul style="list-style-type: none"> <li>■ &gt; 8 mm</li> </ul>			
	<p><b>24.02 Element is warped across the diagonal line, control by diagonal measurement</b></p> <ul style="list-style-type: none"> <li>■ Difference A to B &gt; 5 mm</li> </ul>	 		

# PERI Rental Criteria

## DOMINO











Frame	Description	Instruction	Billing Condition	Tyoe
	<p><b>24.03 Profile dented</b></p>	<p>  Afterwards control of welding         </p>	<p>  088244         </p>	
	<p><b>24.04 Profile edge dented</b></p> <ul style="list-style-type: none"> <li>■ ≤ 3 mm</li> <li>■ &gt; 3 mm</li> </ul>	<p>   </p> <p>  </p>	<p>  </p> <p>  088244         </p>	<p>  </p> <p>  </p>

# PERI Rental Criteria

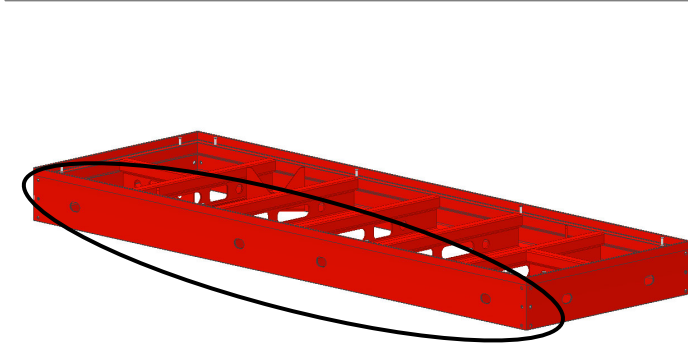
## DOMINO

















Frame	Description	Instruction	Billing Condition	Tyoe
	<p><b>24.05 Front profile deformed</b></p> <ul style="list-style-type: none"> <li>■ Connection of DRS lock not longer possible</li> </ul>			
	<p><b>24.06 Length profile deformed</b></p> <ul style="list-style-type: none"> <li>■ Connection of DRS lock not longer possible</li> </ul>	 		

# PERI Rental Criteria

## DOMINO



Frame	Description	Instruction	Billing Condition	Tyoe
	<b>24.07 Brace bent, deformed</b>			
	■ ≤ 3 mm			
	■ > 3 mm ≤ 10 mm		 088244	
	■ > 10 mm			
	<b>24.08 Anchor steel or anchor lost/ demolished</b>			



# PERI Rental Criteria

## DOMINO

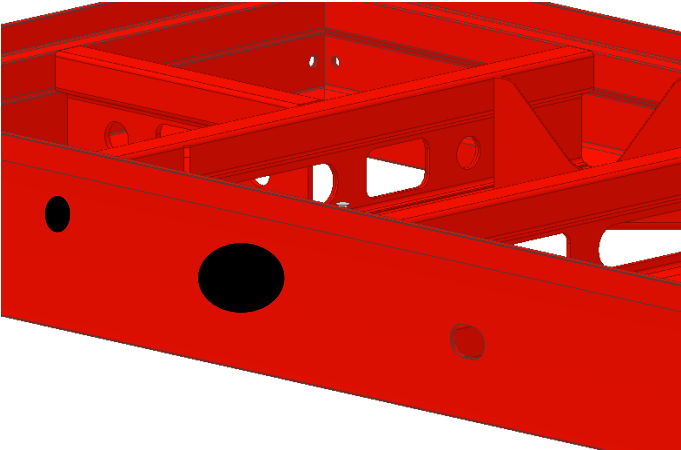

Frame	Description	Instruction	Billing Condition	Tyoe
	<b>24.09 Welding torn of edge or brace</b>		088028	
	<b>24.10 Holes in profile</b>			
	<ul style="list-style-type: none"> <li>■ <math>\leq \text{Ø } 5 \text{ mm}</math></li> </ul>			
	<ul style="list-style-type: none"> <li>■ <math>&gt; \text{Ø } 5 \text{ mm} \leq 15 \text{ mm}</math></li> </ul>		088028	
	<ul style="list-style-type: none"> <li>■ <math>&gt; 15 \text{ mm}</math></li> </ul>			

# PERI Rental Criteria

## DOMINO



### Ins steel Corner DISE

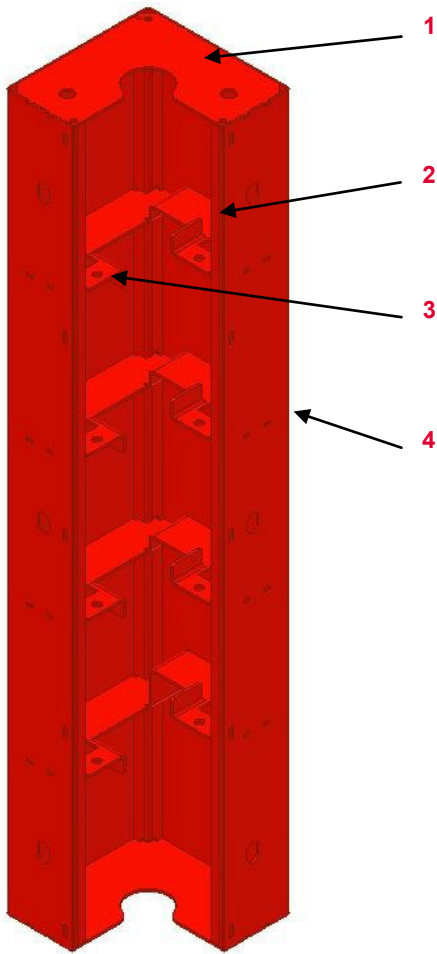











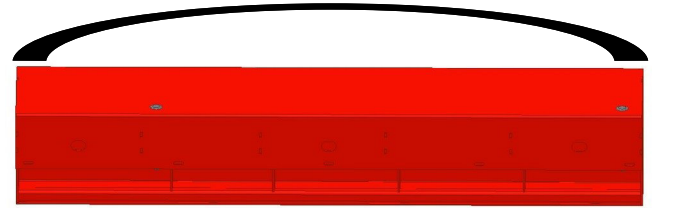

No.	Name	Article number
1	Cover plate	
2	Profil edge	
3	Brace	
4	Formwork shell	

Article	Article number
Ins steel Corner DISE 125	126280
Ins steel Corner DISE 150	126286
Ins steel Corner DISE 250	126242
Ins steel Corner DISE 75	126274

# PERI Rental Criteria

## DOMINO



DISE	Description	Instruction	Billing Condition	Tyoe
	<p><b>24.11 Convex formwork shell</b></p>			
	<p><b>24.12 Profile bent</b></p> <p>■ &gt; 8 mm</p>			
	<p><b>24.13 Dent in formwork shell</b></p> <p>■ &gt; 3 mm</p>		 088027	

# PERI Rental Criteria

## DOMINO



### Articulated corner

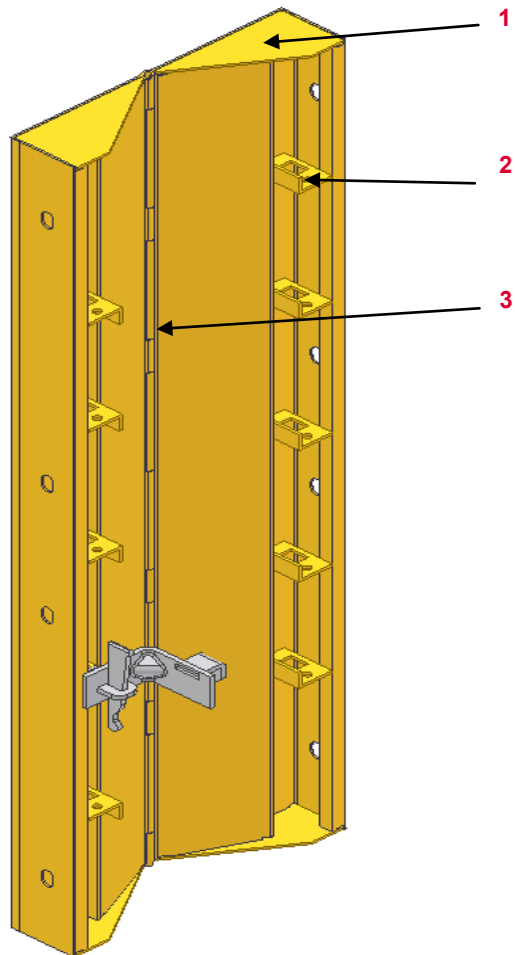

No.	Name	Article number
1	Cover plate	750057
2	Corner	750058
3	Hinge	

Article	Article number
Articulated corner DGE 125	066047
Articulated corner DGE 150	124605
Articulated corner DGE 250	066029
Articulated corner DGE 75	066067

# PERI Rental Criteria

## DOMINO



Articulated corner	Description	Instruction	Billing Condition	Tyoe
--------------------	-------------	-------------	-------------------	------



**24.14 Profile bent**

- > 5 mm



088244

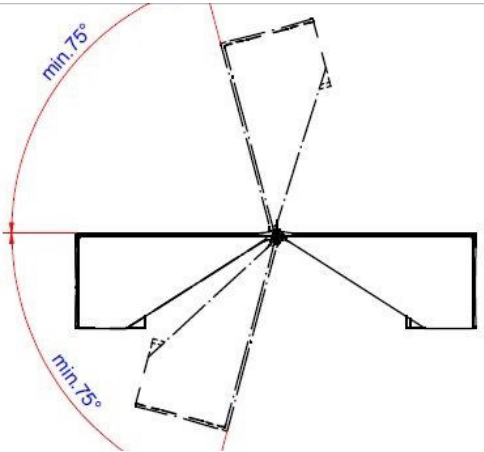

**24.15 Function not satisfied**















- Clean and oil the hinge
- If function is not longer given



# PERI Rental Criteria

## DOMINO



Articulated corner	Description	Instruction	Billing Condition	Tyoe
	<p><b>24.16 Cover plate deformed, demolished</b></p> <ul style="list-style-type: none"> <li>■ If possible</li> <li>■ Or if irreparable</li> </ul>	<p>    </p>	<p>  088027   </p>	<p>    </p>
	<p><b>24.17 Corner damaged</b></p>	<p></p>	<p></p>	<p></p>
	<p><b>24.18 Formwork shell dented</b></p> <ul style="list-style-type: none"> <li>■ &gt; 3 mm</li> </ul>	<p></p>	<p> 088027</p>	<p></p>

# PERI Rental Criteria

## DOMINO



Wall thickness compensation	No.	Name	Article number
-----------------------------	-----	------	----------------

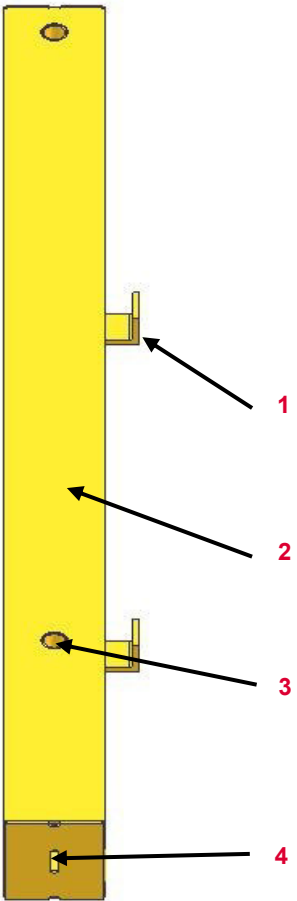



























1	Alu Corner	770257
2	Concrete surface	
3	Alu tube	770258
4	Insert plate	101959

Article	Article number
Wall thickness compensation DWD 125x10	101964
Wall thickness compensation DWD 125x5	066048
Wall thickness compensation DWD 150/5	125944
Wall thickness compensation DWD 150/10	125660
Wall thickness compensation DWD 250x10	101986
Wall thickness compensation DWD 250x5	066030
Wall thickness compensation DWD 75x5	066068

# PERI Rental Criteria

## DOMINO

















Wall tickness compensation	Description	Instruction	Billing Condition	Type
	<b>24.19 Profile bent</b> <ul style="list-style-type: none"> <li>■ &gt; 8 mm</li> </ul>			
	<b>24.20 Concrete surface bent</b> <ul style="list-style-type: none"> <li>■ &gt; 3 mm ≤ 10 mm</li> </ul>			
	<ul style="list-style-type: none"> <li>■ Or &gt; 10 mm</li> </ul>			
	<b>24.21 Deformed cover plate</b> <ul style="list-style-type: none"> <li>■ No damage of welding</li> </ul>		 088244	
	<ul style="list-style-type: none"> <li>■ Or damage of welding</li> </ul>		 088250	
	<b>24.22 Hole in profile</b> <ul style="list-style-type: none"> <li>■ ≤ 3 cm</li> </ul>			
	<ul style="list-style-type: none"> <li>■ &gt; 3 cm</li> </ul>	 		

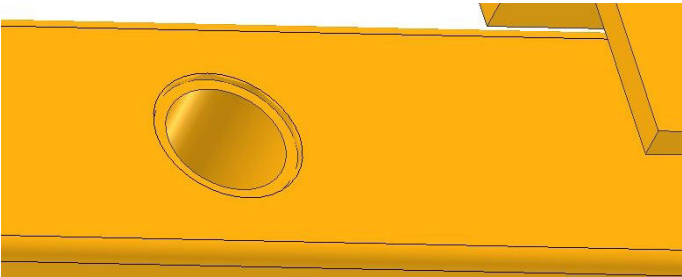

# PERI Rental Criteria

## DOMINO



Wall thickness compensation	Description	Instruction	Billing Condition	Tyoe
	<b>24.23 Corner bent</b>  <ul style="list-style-type: none"> <li>■ ≤ 10 mm</li> <li>■ &gt; 10 mm</li> </ul>	  	 088244   088258	  
	<b>24.24 Corner lost</b>		 088258	
	<b>24.25 Tube damaged/ unusable</b>			

# PERI Rental Criteria

## DOMINO



### Shaft element DSE

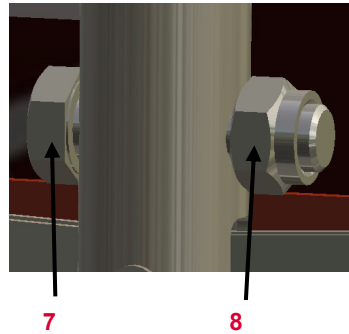
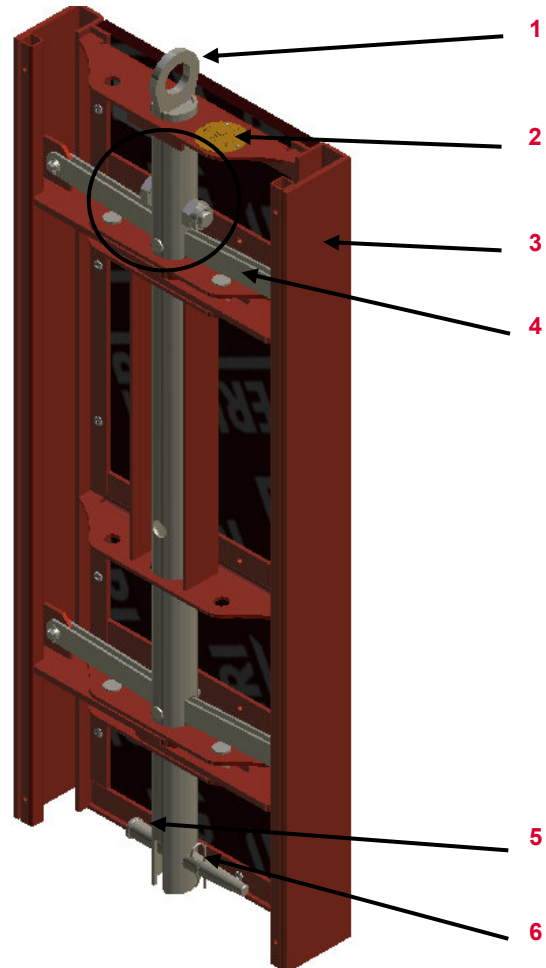











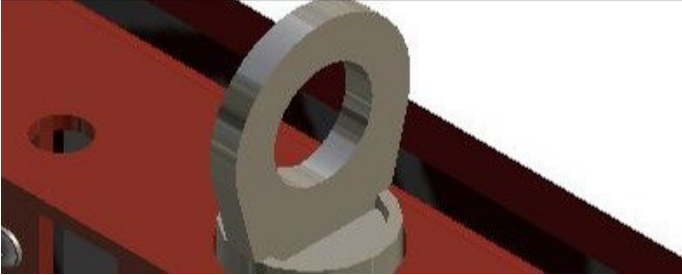



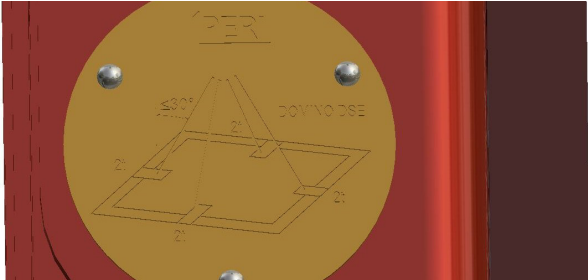

No.	Name	Article number
1	„Kranlasche“	111598
2	“Hinweisschild“	123488
3	Rand brace	
4	„Hebelarm“	111582
5	Pin	111567
6	Cotter pin	018060
7	Screw M24x 90	111571
8	Hex Nut M24	105032

Article	Article number
Shaft element DSE 125	111655
Shaft element DSE 275	111603
Shaft element DSE 300	111617

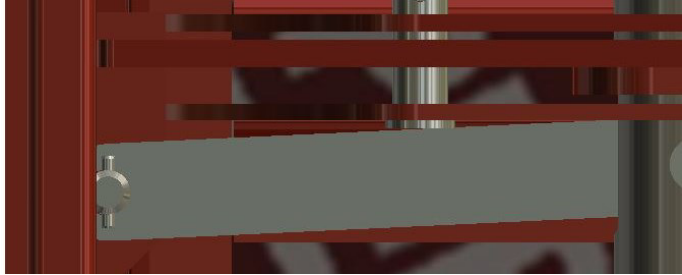
# PERI Rental Criteria

## DOMINO



Shaft element	Description	Instruction	Billing Condition	Tyoe	
	<b>24.26 Crane eye</b>  <ul style="list-style-type: none"> <li>■ Bent</li> </ul>		 088244		
	<ul style="list-style-type: none"> <li>■ Or broken</li> </ul>		111598		
	<b>24.27 Type plate unreadable/ lost</b>		123488		
	<b>24.28 Lever</b>  <ul style="list-style-type: none"> <li>■ Bent</li> </ul>		 088244		
	<ul style="list-style-type: none"> <li>■ Or unusable</li> </ul>		111582		

# PERI Rental Criteria

## DOMINO



Shaft element	Description	Instruction	Billing Condition	Tyoe
---------------	-------------	-------------	-------------------	------

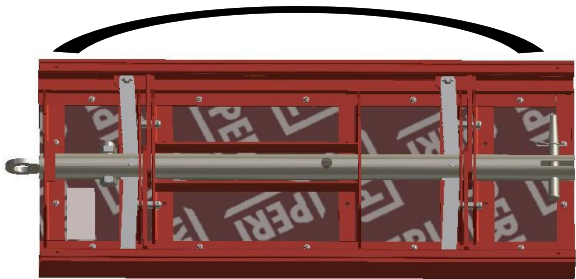

24.29 Rand brace bent



088244

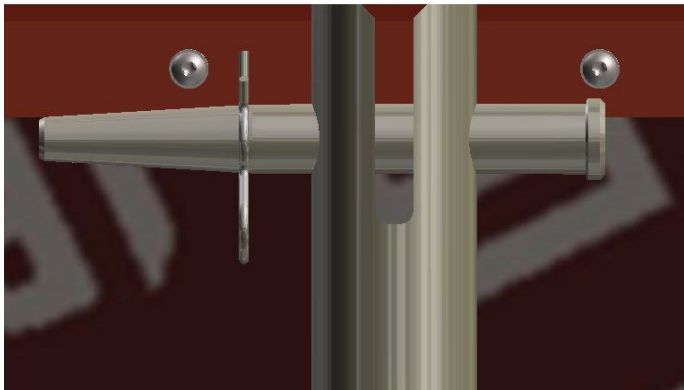

24.30 Pass bolts lost



111567 (Pin)  
018060 (Cotter Pin)



# PERI Rental Criteria

## DOMINO



Spindel Shaft element DSE (111665)	No.	Name	Article number
------------------------------------	-----	------	----------------

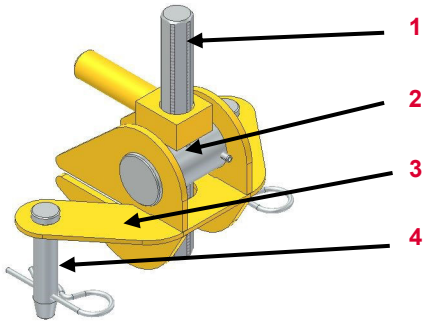

1	Spindle	111658
2	Thread bolts	111664
3	Claw	
4	Bolts	105822

Damage	Name	Instruction	Billing Condition	Type
--------	------	-------------	-------------------	------

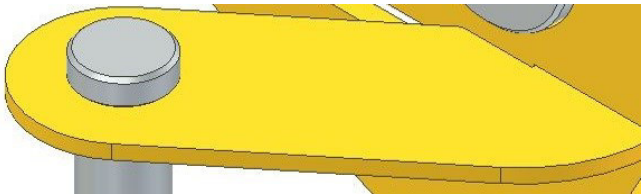

24.31 Claw bent



088244

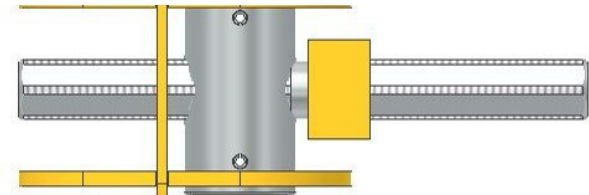

24.32 Spindle/ thread bolts not longer passable

■ If possible



■ Or not possible



088289



# PERI Rental Criteria

## DOMINO



### External corner DAW

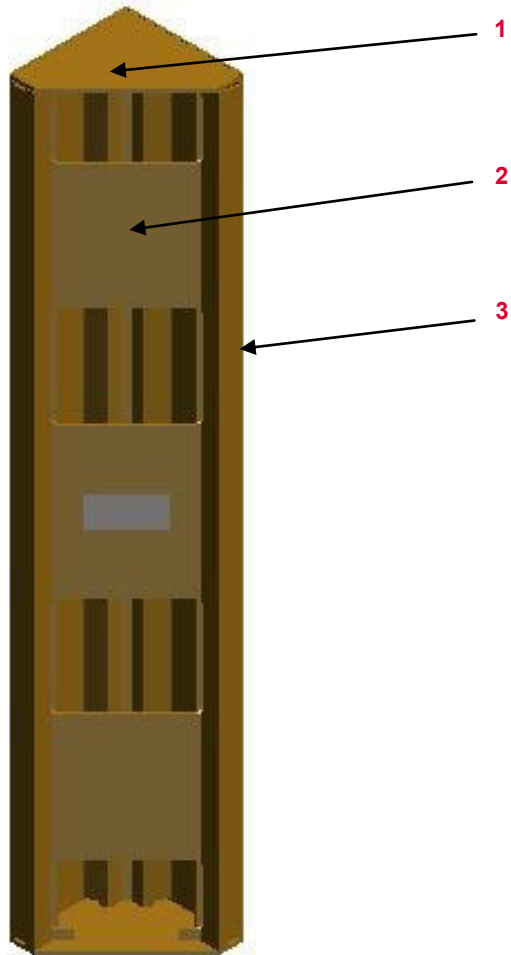













No.	Name	Article number
1	Cover plate	
2	Plate	
3	Concrete surface	

Article	Article number
External corner DAW 75	066066
External corner DAW 125	066046
External corner DAW 150	124608
External corner DAW 250	066028

# PERI Rental Criteria

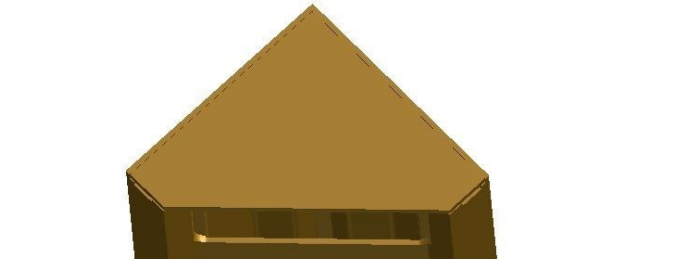
## DOMINO



External corner	Description	Instruction	Billing Condition	Tyoe
	<p><b>24.33 Dent in formwork shell</b></p> <p>■ &gt; 3 mm</p>		 088244	
	<p><b>24.34 Bar unuseable</b></p>			
	<p><b>24.35 Cover plate bent</b></p>		 088250	

# PERI Rental Criteria

## DOMINO



### Stopend panel DOMINO AT

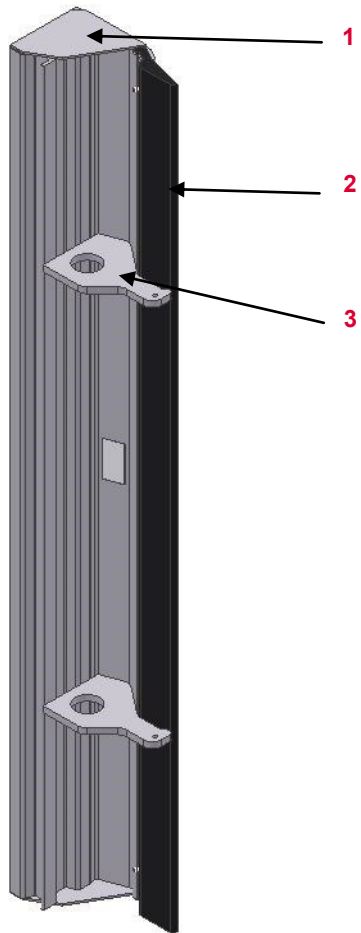

No.	Name	Article number
1	Cover plate	725011
2	Sealing profile	
3	Hook	100781















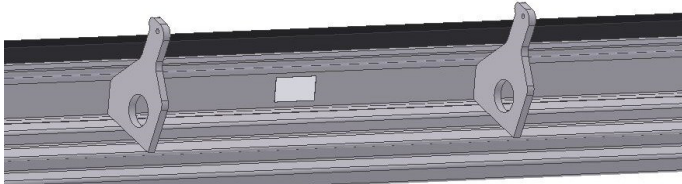

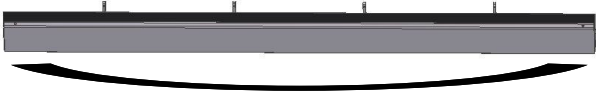

Article	Article number
Stopend panel DOMINO AT 125x3	101934
Stopend panel DOMINO AT 125x5	108856
Stopend panel DOMINO AT 205x3	101927
Stopend panel DOMINO AT 205x5	108855
Stopend panel DOMINO AT 275x3	106203
Stopend panel DOMINO AT 275x5	108857

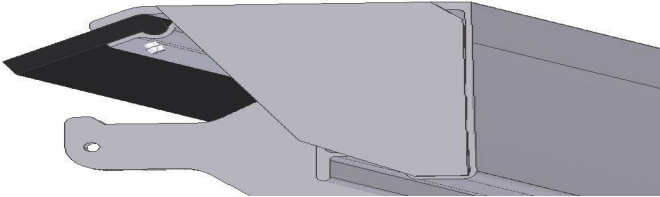

# PERI Rental Criteria

## DOMINO



Stopend panel AT	Description	Instruction	Billing Condition	Tyoe
	<b>24.36 Sealing profile carved, torn</b> <ul style="list-style-type: none"> <li>■ &gt; 3 mm deep</li> </ul>			
	<b>24.37 Hook broken, lost</b>		 088154	
	<b>24.38 Profile bent</b> <ul style="list-style-type: none"> <li>■ &gt; 8 mm</li> </ul>			
	<b>24.39 Cover plate damaged</b> <ul style="list-style-type: none"> <li>■ &gt; 3 mm to ≤10 mm</li> <li>■ Or &gt; 10 mm</li> </ul>	 	 088244  088250	 

# PERI Rental Criteria

## DOMINO



### Stopend panel DOMINO MTF

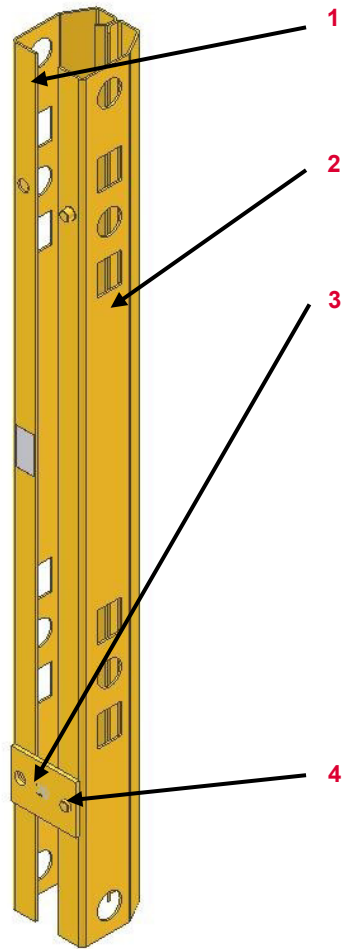

No.	Name	Article number
-----	------	----------------

1	Middle part right	725011
2	Middle part left	
3	Platte 20	101804
4	Bolts	101215







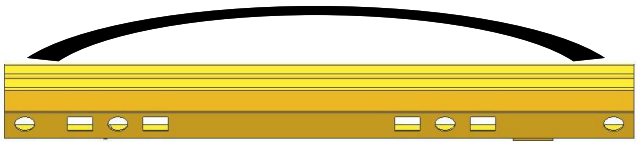

Article	Article number
---------	----------------

Stopend Panel DOMINO MTF 125 x 20	101935
Stopend Panel DOMINO MTF 125 x 24/25	101936
Stopend Panel DOMINO MTF 125 x 30	101937
Stopend Panel DOMINO MTF 125 x 35/36	101940
Stopend Panel DOMINO MTF 250 x 20	101928
Stopend Panel DOMINO MTF 250 x 24/25	101929
Stopend Panel DOMINO MTF 250 x 30	101930
Stopend Panel DOMINO MTF 250 x 35/36	101931

# PERI Rental Criteria

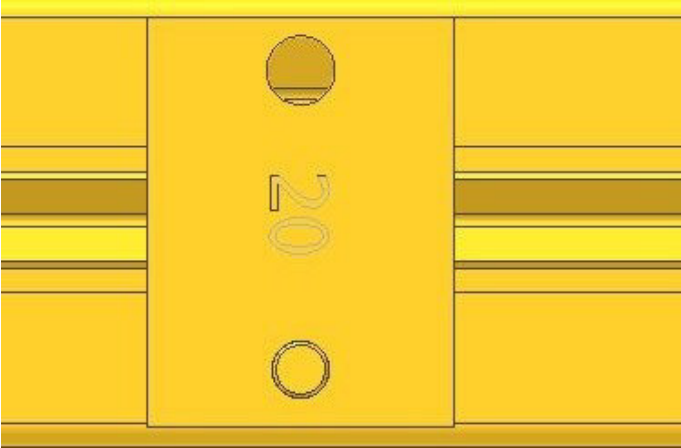
## DOMINO















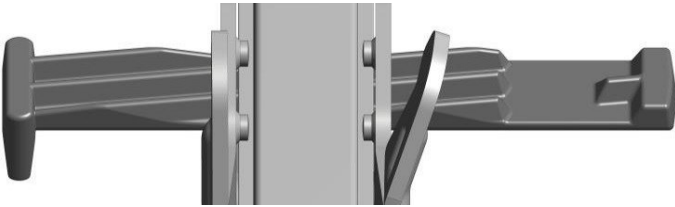

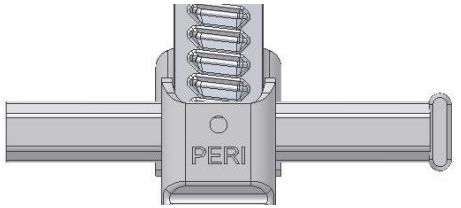

Stoepend panel MTF	Description	Instruction	Billing Condition	Tyoe
	<p>24.40 Profile bent, deformed</p> <ul style="list-style-type: none"> <li>■ &gt; 8 mm</li> </ul>			
	<p>24.41 Plate bent/ unuseable</p>		 088166	

# PERI Rental Criteria

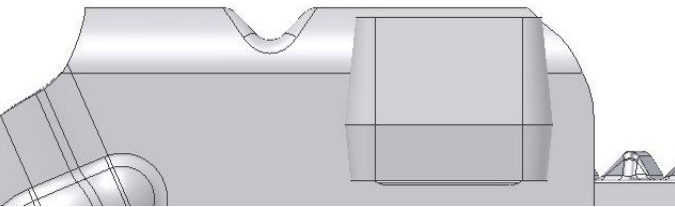
## DOMINO



Alignment coupler DRS (066080)	Description	Instruction	Billing Condition	Tyoe
	<p>24.42 Lock fallen apart</p>		 088031	
	<p>24.43 Retaining claw bent</p>		 088032	
	<p>24.44 Wedge not longer passable</p>			
	<p>24.45 Hitting surface broken</p>			

# PERI Rental Criteria

## DOMINO



Wedge clamp DKS (066081)	No.	Name	Article number
	1	Wedge	100703
	2	Niet	107521
	3	Claw	

Damage	Name	Instruction	Billing Condition	Type
	24.46 Wedge lost		088260	
	24.47 Claw bent		088244	

# PERI Rental Criteria

## DOMINO



DOMINO Compensation waler DAR 80 (066084)	No.	Name	Article number
---	-----	------	----------------

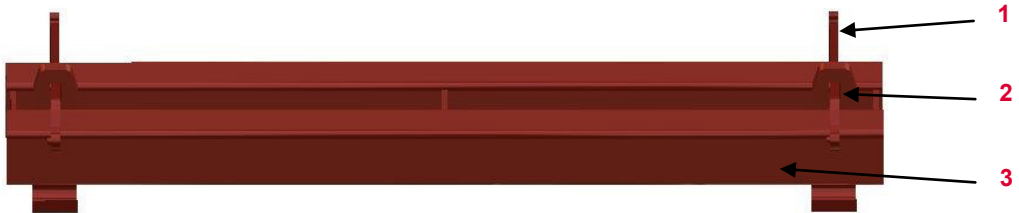

1	Wedge	723318
2	„Hackenführung“	723321
3	Profile	

Damage	Name	Instruction	Billing Condition	Type
--------	------	-------------	-------------------	------

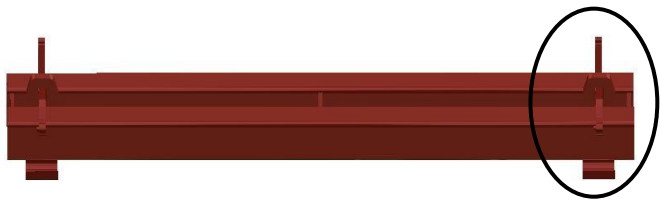

24.48 Guide and wedge defect/lost



088259

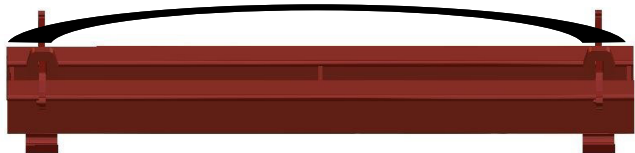

24.49 Profile bent



















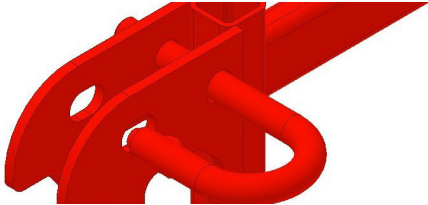



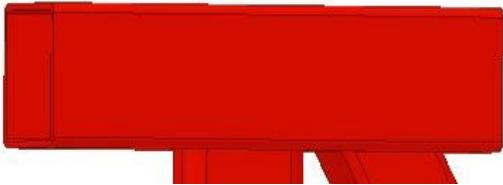

■ > 8 mm

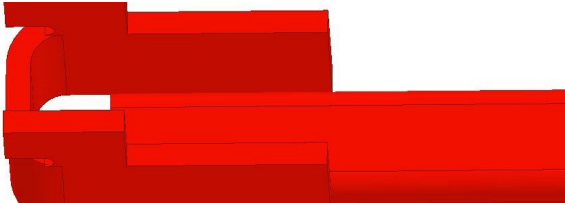

# PERI Rental Criteria

## DOMINO



Scaffold bracket DG 85 (066085)	Description	Instruction	Billing Condition	Tyoe
	<b>24.50 Cracked welding</b> <ul style="list-style-type: none"> <li>■ Deformation of material</li> </ul>	 		
	<ul style="list-style-type: none"> <li>■ Or not deformation of material</li> </ul>	 		
	<b>24.51 Hook bent</b>			088244 
	<b>24.52 Vertical tube deformed</b> <ul style="list-style-type: none"> <li>■ If possible</li> </ul>			088244 
	<ul style="list-style-type: none"> <li>■ Or not possible</li> </ul>	 		
	<b>24.53 Bent part</b>			088244 

# PERI Rental Criteria

## DOMINO



Guardrail post holder DOMINO (106877)	No.	Name	Article number
---------------------------------------	-----	------	----------------

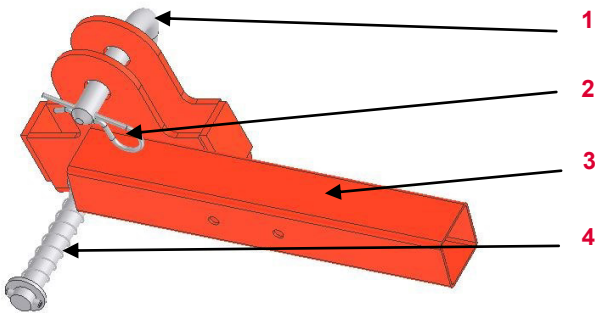

1	Plug	721814
2	Cottor pin	018060
3	Grundkörper	
4	„Druckfeder“	721816

Damage	Name	Instruction	Billing Condition	Type
--------	------	-------------	-------------------	------

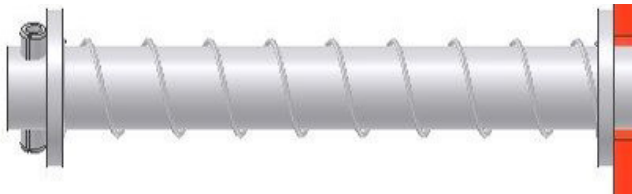

24.54 Spring lost

 721816 („Druckfeder“)  
711074 (Disk)  
710912 (Roll pin)

 088264

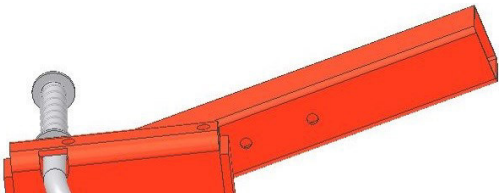

24.55 Basic body bent



 088244





# PERI Rental Criteria

## DOMINO

















HSGP-2 (116292)	Description	Instruction	Billing Condition	Tyoe
	<p><b>24.56 Slider deformed, lost</b></p>	 115673	 088227	
	<p><b>24.57 Bracket broken</b></p>		 088229	
	<p><b>24.58 Bent, deformed</b></p> <p>■ &gt; 5 mm</p>			

# PERI Rental Criteria

## DOMINO



















Stacking device DSR (066094)	Description	Instruction	Billing Condition	Tyoe
	<p><b>24.59 Broken welding at the latch</b></p> <ul style="list-style-type: none"> <li>■ Damaged by force (with damage of the device)</li> <li>■ Or broken without force (no damage of the device)</li> </ul>	<p>   </p> <p>   </p>	<p>  </p> <p>  </p>	<p>  </p> <p>  </p>
	<p><b>24.60 Type plate missing   not readable</b></p>	<p>  750059 (type plate)   710217 (rivet)         </p>	<p>  </p>	<p>  </p>

# PERI Rental Criteria

## DOMINO



Icon	Significance	Icon	Significance	Icon	Significance
	Not OK – material is scrap		Billing necessary (customer)		Optical damage
	OK—material stays in rental park		No Billing necessary		Functional damage
	Scrap material—it's not permitted to hand out the material because of safety aspects		Shorten material		Functional damage—it's not permitted to hand out the material
	Repair according to Instruction		Mark material		Static damage—it's not permitted to hand out the material
	Fix material cold		Replace damaged material		
	Repair after local economic efficiency calculation		Replace missing material		
	Clean material				