

PERI Rental Criteria

MULTIPROP



Contact

PERI GmbH
Formwork Scaffolding
Engineering
 P.O. Box 1264
 89259 Weissenhorn, Germany
 Phone +49 (0) 7309.950-0
 Fax +49 (0) 7309.951-0
rental-criteria@peri.de

Content	Page
MULTIPROP Prop	2
Frame MRK	11
Accessories	16
Glossary	36

Changes	Date Initial	Page
New version	09/2015 fw	
20.05.03 Measuring tape missing/ broken added	02/2017 fw	4
20.05.05 If hole ≤ 5 mm added	02/2017 fw	4
20.05.09 old version: not trendsetting added	02/2017 fw	6
20.05.12 Prop is still moving added	02/2017 fw	11
20.05.14 New picture	02/2017 fw	12
20.05.52/ 53/ 54/ 55 New	02/2017 fw	7/8/14
20.05.56 New	05/2018 fw	9
New damages MP Beam added	05/2018 fw	33-34

PERI Rental Criteria

MULTIPROP



MULTIPROP Prop	No.	Name	Article number
----------------	-----	------	----------------

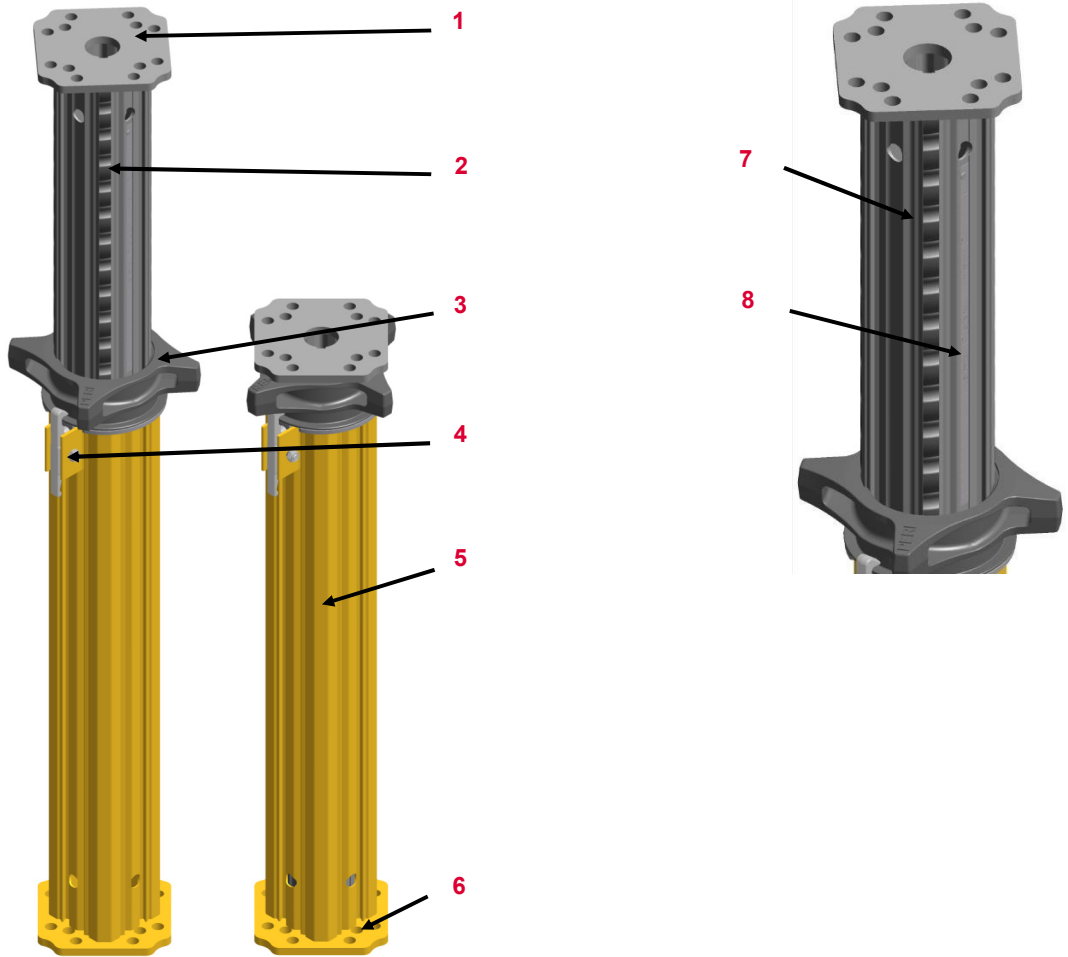























1	Head plate	
2	Inner tube	
3	Collar	710273
4	Trigger	710418
5	Outer tube	
6	Ground plate	
7	Thread	
8	Flange	

Valid for	Article number
MULTIPROP MP 120	027288
MULTIPROP MP 250	027289
MULTIPROP MP 350	027290
MULTIPROP MP 480	027291
MULTIPROP MP 625	027305

PERI Rental Criteria

MULTIPROP























Prop	Description	Instruction	Billing Condition	Type
	20.05.01 Dent in outer tube			
	<ul style="list-style-type: none"> ■ If tube not moveable 		 088381	
	<ul style="list-style-type: none"> ■ Or if outer tube not reparable and if possible 	 Exchange outer tube	 See table (p. 10)	
	<ul style="list-style-type: none"> ■ Or exchange not possible 	 		
	20.05.02 Dent in inner tube			
	<ul style="list-style-type: none"> ■ Tube not moveable 	 Exchange inner tube	 See table (p. 10)	
	<ul style="list-style-type: none"> ■ Or > 2 mm in thread area and if possible ■ Or > 3 mm in flange area 	 Exchange inner tube	 See table (p. 10)	
	<ul style="list-style-type: none"> ■ Or if not possible 	 		

PERI Rental Criteria

MULTIPROP

















Prop	Description	Instruction	Billing Condition	Type		
	25.05.03 Heavy soiled inner tube or measuring tape <ul style="list-style-type: none"> ■ If possible ■ Or if not possible ■ Or measuring tape missing/ broken 					
			Exchange measuring tape or tube		See table (p. 10)	
			Exchange measuring tape or tube		See table (p. 10)	
	25.05.04 Slide piece loose			088380		
	25.05.05 Hole in outer tube <ul style="list-style-type: none"> ■ $\leq \varnothing 5$ mm ■ $> \varnothing 5$ mm 					
			Exchange outer tube		See table (p. 10)	

PERI Rental Criteria

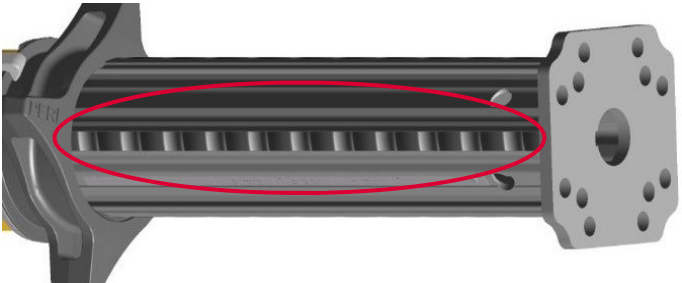
MULTIPROP











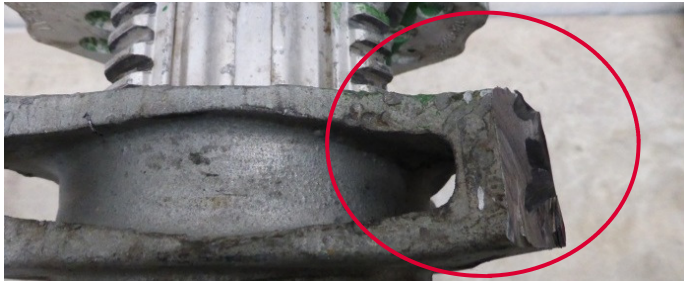





Prop	Description	Instruction	Billing Condition	Type
	20.05.06 Head or ground plate bent			
	<ul style="list-style-type: none"> ■ Bent until 20 mm 			
	<ul style="list-style-type: none"> ■ Or bent > 20 mm 			
	20.05.07 Crack in welding			
	20.05.08 Thread soiled with concrete			

PERI Rental Criteria

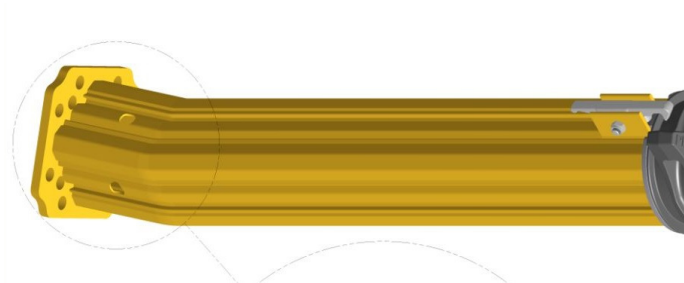
MULTIPROP



Prop	Description	Instruction	Billing Condition	Type
	20.05.09 Collar (old version: not trendsetting)			
	<ul style="list-style-type: none"> ■ Parts torn out 		 088378	
	<ul style="list-style-type: none"> ■ Or crack in the collar 		 088378	
	20.05.10 Trigger damaged, function not available		 088372	
	20.05.11 Complete prop bent	 		
	<ul style="list-style-type: none"> ■ Tube not moveable 			

PERI Rental Criteria

MULTIPROP



Prop	Description	Instruction	Billing Condition	Type
------	-------------	-------------	-------------------	------



20.05.52 Cracks in collar (new Version trendsetting)



710273



New Vesion: Trendsetting (since 2015)

Old Version until 2015



PERI Rental Criteria

MULTIPROP



Prop	Description	Instruction	Billing Condition	Type
------	-------------	-------------	-------------------	------



20.05.53 Copy of MULTIPROP prop





- Can be identified at the collar (PERI should be stamped in)



PERI Rental Criteria

MULTIPROP



Prop	Description	Instruction	Billing Condition	Type
	20.53.56 End plate cracked cut in	 Replace inner or outer tube		

PERI Rental Criteria

MULTIPROP



Article	Exchange measuring tape		Exchange outer tube		Exchange inner tube	
	Spare parts	Service article number	Spare part	Service article number	Spare part	Service article number
MULTIPROP MP 120	710421	088370	702048	088401	702050	088400
MULTIPROP MP 250	710406	088374	702038	088403	702040	088402
MULTIPROP MP 350	710414	088375	702029	088405	702028	088404
MULTIPROP MP 480	710407	088376	702034	088407	720606	088406
MULTIPROP MP 625	720609	088373	720603	088409	720606	088408

PERI Rental Criteria

MULTIPROP



MULTIPROP Frame MRK		No.	Name	Article number
---------------------	--	-----	------	----------------

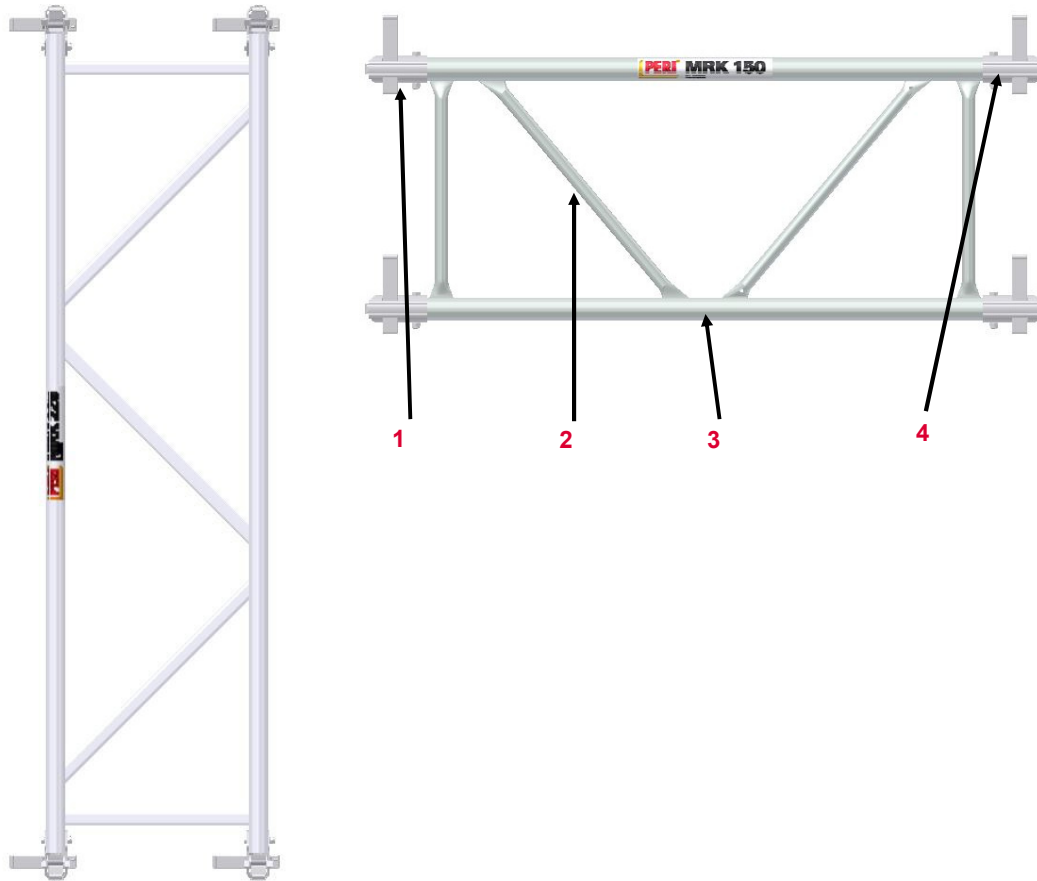









1	Connector C	105881
2	Strut	
3	Frame	
4	Connector D	105874

Valid for	Article number
Frame MRK 62,5	028390
Frame MRK 75	028400
Frame MRK 90	028330
Frame MRK 120	028340
Frame MRK 137,5	028380
Frame MRK 150	028350
Frame MRK 201,5	028460
Frame MRK 225	028360
Frame MRK 230	028470
Frame MRK 237	028480
Frame MRK 266	028490
Frame MRK 296	028370

PERI Rental Criteria

MULTIPROP



MRK	Description	Instruction	Billing Condition	Type
	<p>20.05.12 Function of the connector not available (Prop is still moving)</p>	 <p>105881 (Connector C) 105874 (Connector D)</p>		
	<p>20.05.13 Bent skin at the connector</p>	 <p>105881 (Connector C) 105874 (Connector D)</p>	 <p>088379</p>	

PERI Rental Criteria

MULTIPROP



MRK	Description	Instruction	Billing Condition	Type
-----	-------------	-------------	-------------------	------

20.05.14 Bent frame



■ ≤ permitted bend (l/500)



■ Or > permitted bend















Article	Perm. bent
MRK 62,5	3,0 mm
MRK 75	3,0 mm
MRK 90	3,0 mm
MRK 120	3,0 mm
MRK 137,5	3,0 mm
MRK 150	3,0 mm
MRK 201,5	4,0 mm
MRK 225	4,5 mm
MRK 230	4,5 mm
MRK 237	5,0 mm
MRK 266	5,0 mm
MRK 296	6,0 mm

PERI Rental Criteria

MULTIPROP

















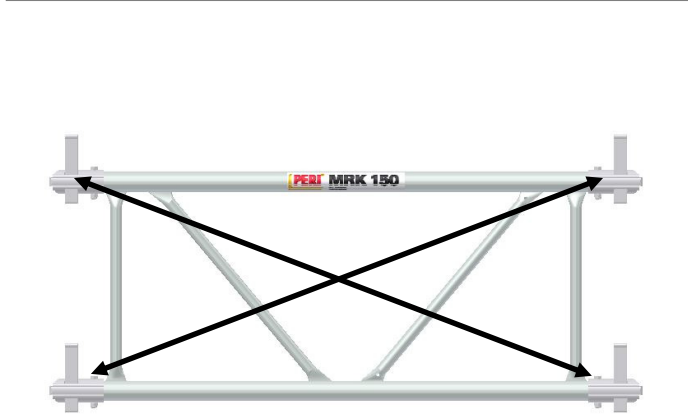

MRK	Description	Instruction	Billing Condition	Type
	<p>20.05.15 Wedge rusty worn</p> <ul style="list-style-type: none"> ■ Function not available 	<p>105881 (Connector C) 105874 (Connector D)</p> 		
	<p>20.05.16 Crack in welding</p> <ul style="list-style-type: none"> ■ Without deformation ■ Or with deformations 	<p>Without deformation:  </p> <p>Or with deformations:  </p>	<p>Without deformation: </p> <p>Or with deformations: </p>	<p>Without deformation: </p> <p>Or with deformations: </p>

PERI Rental Criteria

MULTIPROP



















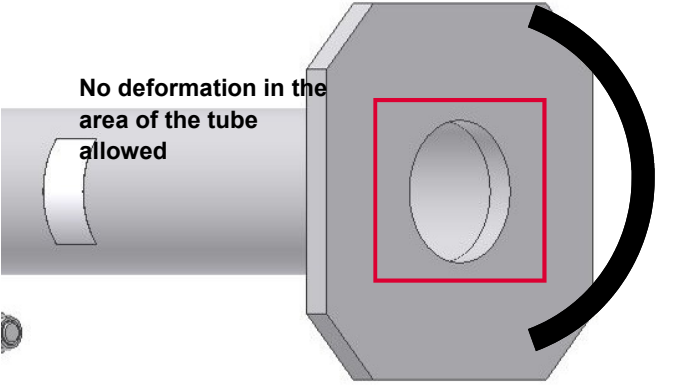

MRK	Description	Instruction	Billing Condition	Type
	<p>20.05.54 Brace bent</p> <ul style="list-style-type: none"> ■ If possible ■ Or edges of the brace affected ■ Or kink in brace 	<ul style="list-style-type: none"> ■ If possible:  ■ Or edges of the brace affected:  ■ Or kink in brace:  	<ul style="list-style-type: none"> ■ If possible:  ■ Or edges of the brace affected:  ■ Or kink in brace:  	<ul style="list-style-type: none"> ■ If possible:  ■ Or edges of the brace affected:  ■ Or kink in brace: 
	<p>20.05.55 MRK bent diagonally</p> <ul style="list-style-type: none"> ■ If possible ■ Or if not possible 	<ul style="list-style-type: none"> ■ If possible:  ■ Or if not possible:  	<ul style="list-style-type: none"> ■ If possible:  ■ Or if not possible:  	<ul style="list-style-type: none"> ■ If possible:  ■ Or if not possible: 

PERI Rental Criteria

MULTIPROP

















Feet MP 50 (027310)

	Description	Instruction	Billing Condition	Type
	<p>20.05.17 Tube bent</p> <ul style="list-style-type: none"> ■ ≤ 6 mm depth ≤ Ø 60 mm ■ Or > 6 mm depth ■ Or > Ø 60 mm 	<ul style="list-style-type: none">      	<ul style="list-style-type: none">    	<ul style="list-style-type: none">   
 <p>No deformation in the area of the tube allowed</p>	<p>20.05.18 Head or base plate bent</p> <ul style="list-style-type: none"> ■ ≤ 15 mm ■ Or > 15 mm 	<ul style="list-style-type: none">    	<ul style="list-style-type: none">  088244  	<ul style="list-style-type: none">  

PERI Rental Criteria

MULTIPROP











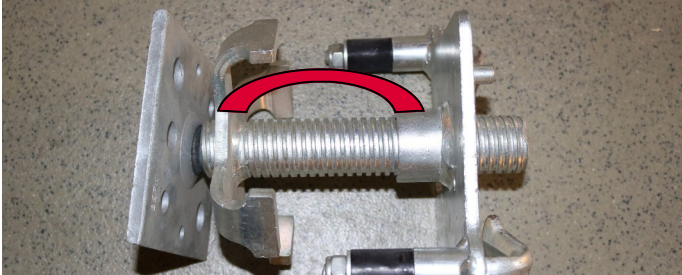



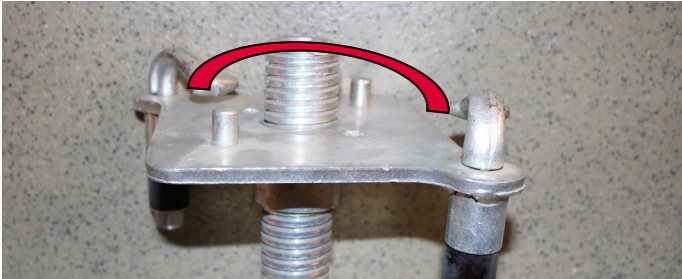

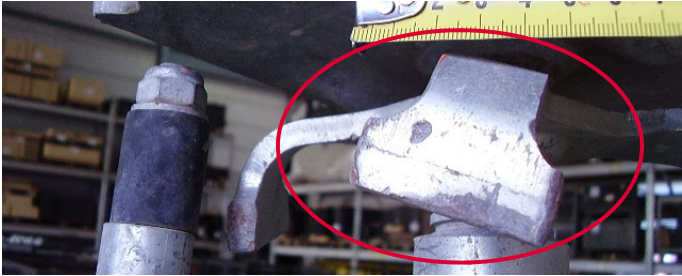

Feet MP 50 (027310)	Description	Instruction	Billing Condition	Type
	<p>20.05.19 Spring tube damaged, missing</p> <ul style="list-style-type: none"> ■ Spring tube 1st. Version (black) ■ Or spring tube 2nd. Version (orange) 	<p></p> <p></p>	<p> 088367</p> <p></p>	<p></p> <p></p>
	<p>20.05.20 Tension claw damaged, missing</p>	<p> 780108 (spring tube) 780105 (tension claw) 710381 (nut) 780702 (washer 2x)</p>	<p> 088368</p>	<p></p>
	<p>20.05.21 Tension claw not tightened</p> <ul style="list-style-type: none"> ■ Tension claw should have some resistance when moved by hand 	<p></p>	<p></p>	<p></p>

PERI Rental Criteria

MULTIPROP

















Tilting base MKF (027296)	Description	Instruction	Billing Condition	Type
	20.05.22 Spindle bent ■ > 5 mm	 		
	20.05.23 Head or ground plate bent ■ > 5 mm		 088244	
	20.05.23 Rotor bent ■ Without crack in rotor ■ Or with crack in rotor	If possible   	 088244 	 

PERI Rental Criteria

MULTIPROP











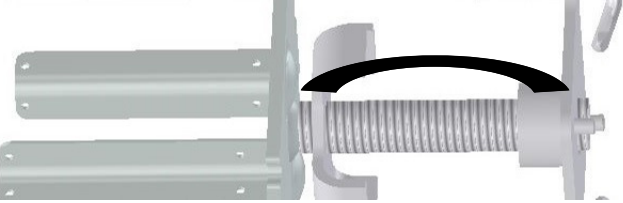













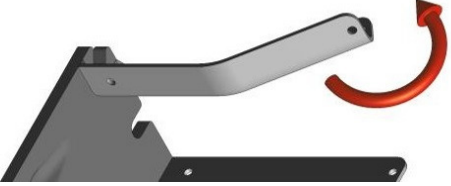

Tilting base MKF (027296)	Description	Instruction	Billing Condition	Type
	20.05.25 Spring tube damaged, missing			
	<ul style="list-style-type: none"> ■ Spring tube 1st. Version (black) ■ Or spring tube 2nd. Version (orange) 	 	 	088367  
	20.05.26 Tension claw damaged, missing			780108 (spring tube) 780105 (tension claw) 710381 (nut) 780702 (washer 2x) 
	20.05.27 Tension claw not tightened	<ul style="list-style-type: none"> ■ Tension claw should have some resistance when moved by hand 		 

PERI Rental Criteria

MULTIPROP

















Tilting forkhead MKK (027297)	Description	Instruction	Billing Condition	Type
	<p>20.05.28 Spindle bent</p> <ul style="list-style-type: none"> ■ > 5 mm 	 		
	<p>20.05.29 Head or ground plate bent</p> <ul style="list-style-type: none"> ■ > 5 mm 	 		
	<p>20.05.30 Rotor bent</p> <ul style="list-style-type: none"> ■ Without crack in rotor ■ Or with crack in rotor 	<p> If possible</p> <p> </p>	<p> 088244</p> <p> 088244</p>	<p></p> <p></p>
	<p>20.05.31 Plaid bent</p> <ul style="list-style-type: none"> ■ Without crack in welding ■ Or with crack in welding 	<p></p> <p></p>	<p> 088395</p> <p> 088394</p>	<p></p> <p></p>

PERI Rental Criteria

MULTIPROP



Tilting forkhead MKK (027297)	Description	Instruction	Billing Condition	Type
	20.05.32 Spring tube damaged, missing			
	<ul style="list-style-type: none"> ■ Spring tube 1st. Version (black) ■ Or spring tube 2nd. Version (orange) 	 	  088367	 
	20.05.33 Tension claw damaged, missing		 088368	
	20.05.34 Tension claw not tightened	<ul style="list-style-type: none"> ■ Tension claw should have some resistance when moved by hand 	 	

PERI Rental Criteria

MULTIPROP



Universal tripod (028000)	No.	Name	Article number
---------------------------	-----	------	----------------

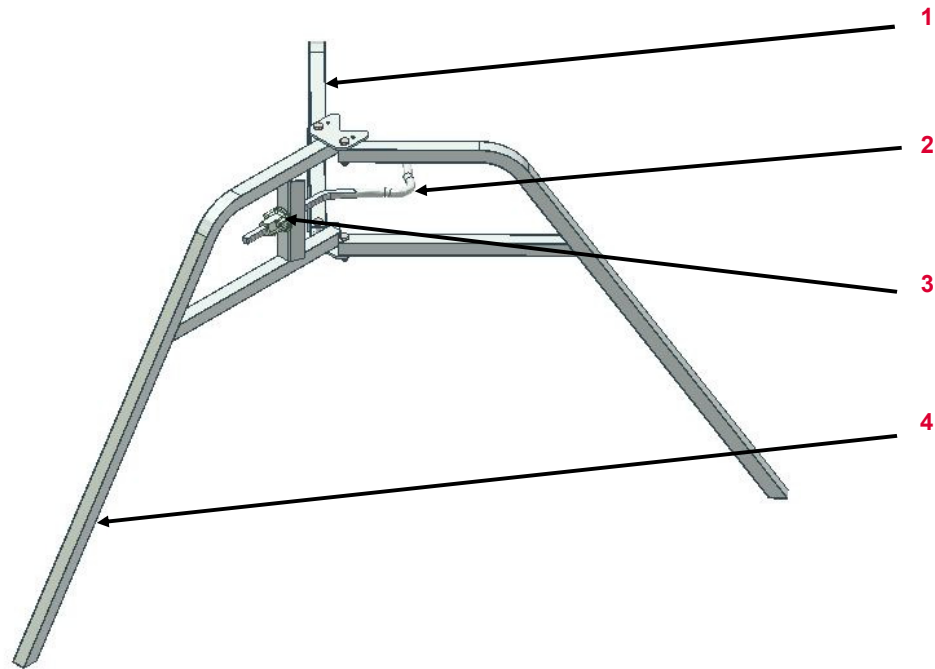

1	Pivoting leg	715643
2	Tension hoop	710161
3	Cam nut	030130
4	Support leg	715642

PERI Rental Criteria

MULTIPROP



Universal tripod	Description	Instruction	Billing Condition	Type
------------------	-------------	-------------	-------------------	------



20.05.35 Pivoting arm bent

- If bending possible
- Or if not possible



088244



715643 (Pivoting Arm)



089149



20.05.36 support leg bent

- If possible
- Or if not possible



088244



PERI Rental Criteria

MULTIPROP



Universal tripod	Description	Instruction	Billing Condition	Type
------------------	-------------	-------------	-------------------	------



20.05.37 Tension hoop bent

- > 100°



20.05.38 Nut at the cam nut broken



030130 (cam nut)
767043 (grooved pin)



088429



PERI Rental Criteria

MULTIPROP



Scaffolding tube	No.	Name	Article number
------------------	-----	------	----------------

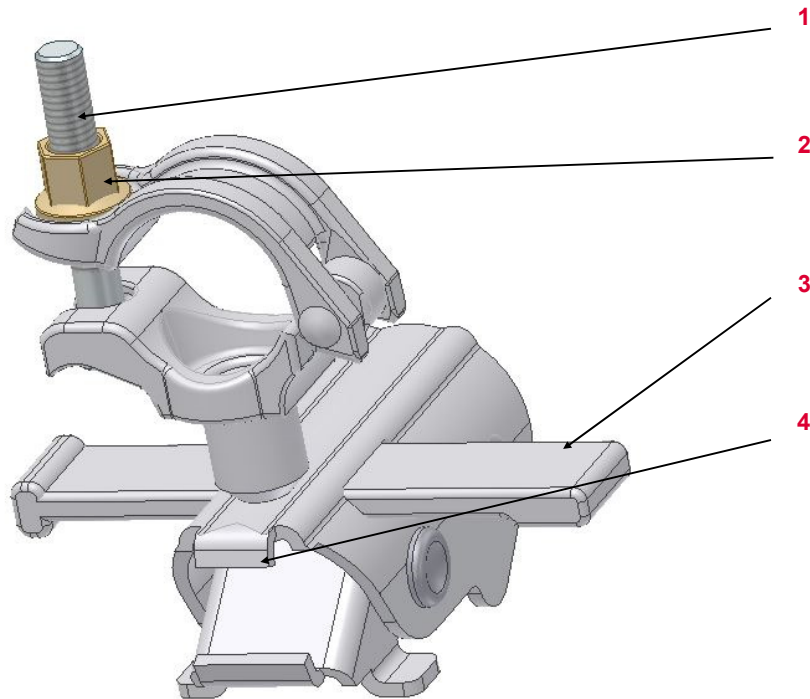











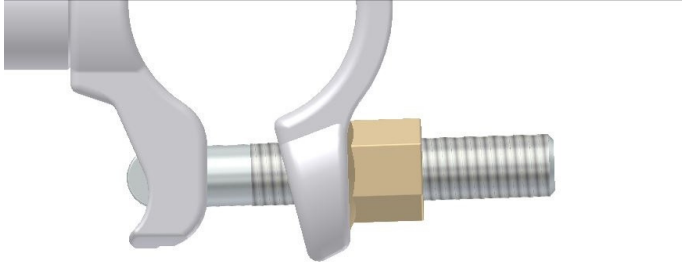

1	Hammer head bolt	710702
2	Nut	710340
3	Wedge	
4	Connector	

Valid for	Article number
Scaffolding tube MG-A/C	027298
Scaffolding tube MG-B/D	027299

PERI Rental Criteria

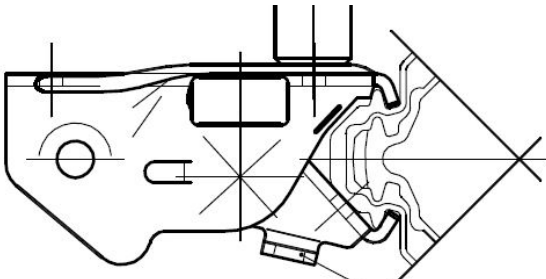
MULTIPROP



Scaffolding tube	Description	Instruction	Billing Condition	Type
	20.05.39 Hammer head bolt defect, missing	 710702 (Hammer head bolt) 710340 (Nut)	 088388 088360	
	20.05.40 Function of the wedge not available	 		
	20.05.41 Connection to MULTIPTOP Prop not possible	 		

PERI Rental Criteria

MULTIPROP



Connector MPV-2 (027301)	Description	Instruction	Billing Condition	Type
--------------------------	-------------	-------------	-------------------	------

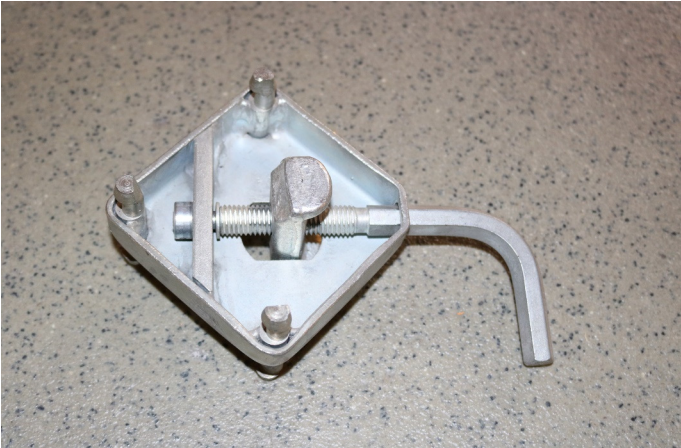

20.05.42 Bolt or spanner missing



20.05.43 Bent, deformed



PERI Rental Criteria

MULTIPROP



MULTIPROP Strap (027302)	Description	Instruction	Billing Condition	Type
--------------------------	-------------	-------------	-------------------	------



20.05.44 Bracket bent | missing



20.05.45 Yoke bent

■ > 10 mm



PERI Rental Criteria

MULTIPROP



Tension strap (111000)	Description	Instruction	Billing Condition	Type
------------------------	-------------	-------------	-------------------	------



20.05.46 Thread bent

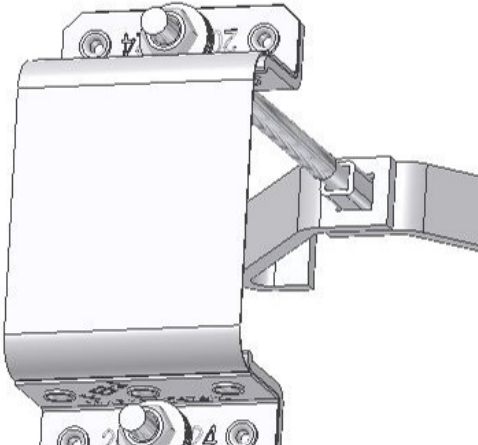

20.05.47 Plate damaged, deformed



PERI Rental Criteria

MULTIPROP



Aluminium beam MPB 24





No.	Name	Article number
-----	------	----------------

Valid for	Article number
Beam MPB 24, L= 3,00 m	079300
Beam MPB 24, L= 3,60 m	079360
Beam MPB 24, L= 4,20 m	079420
Beam MPB 24, L= 4,80 m	079480
Beam MPB 24, L= 5,40 m	079540
Beam MPB 24, L= 6,00 m	079600

PERI Rental Criteria

MULTIPROP



MPB Beam	Description	Instruction	Billing Condition	Type
	<p>20.05.48 Nail holes</p> <ul style="list-style-type: none"> ■ ≤ Ø 5 mm ■ Or > Ø 5 mm 	<ul style="list-style-type: none"> ■ ✓ ■ 🗑️ 🚫 	<ul style="list-style-type: none"> ■ 🚫 ■ 📊 	<ul style="list-style-type: none"> ■ 👁️ ■ ⚠️
	<p>20.05.49 Beam shortened</p> <ul style="list-style-type: none"> ■ Just permitted in combination with the correct drilling of the holes 	<ul style="list-style-type: none"> ■ ✓ 	<ul style="list-style-type: none"> ■ 🚫 	<ul style="list-style-type: none"> ■ 👁️

PERI Rental Criteria

MULTIPROP



MPB Beam	Description	Instruction	Billing Condition	Type
----------	-------------	-------------	-------------------	------

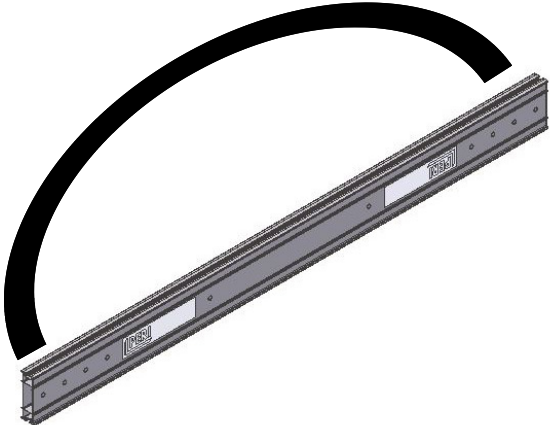

20.05.50 Beam bent

■ ≤ permitted bent



■ Or > permitted bent













Article	Perm. bent
MPB 24, L= 3,00 m	6,0 mm
MPB 24, L= 3,60 m	7,0 mm
MPB 24, L= 4,20 m	9,0 mm
MPB 24, L= 4,80 m	9,5 mm
MPB 24, L= 5,40 m	11,0 mm
MPB 24, L= 6,00 m	12,0 mm

PERI Rental Criteria

MULTIPROP







MPB Beam	Description	Instruction	Billing Condition	Type
	<p>20.05.57 Soiled guide profile</p> <ul style="list-style-type: none"> ■ If possible ■ Or if not possible anymore 	<p>   </p>	<p>   </p>	<p>   </p>
	<p>20.05.58 Cracks in inner profile</p>	<p>  </p>	<p>  </p>	<p>  </p>

PERI Rental Criteria

MULTIPROP



MPB Beam	Description	Instruction	Billing Condition	Type
	25.05.59 Crack in outer profile			

PERI Rental Criteria

MULTIPROP



Splice MPB (107348)	Description	Instruction	Billing Condition	Type
---------------------	-------------	-------------	-------------------	------

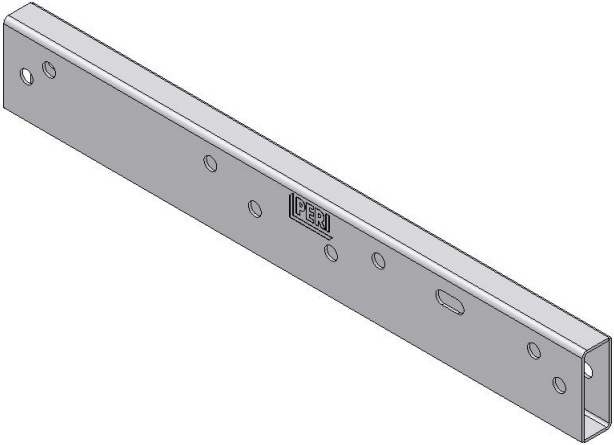

















20.05.51 Splice bent



PERI Rental Criteria

Glossary Icons



Icon	Significance	Icon	Significance	Icon	Significance
	Not Ok– material is scrap		Billing necessary (customer)		Optical damage
	OK– material stays in rental park		No Billing necessary		Functional damage
	Scrap material– it's not permitted to hand out the material because of safety aspects		Shorten the material		Functional damage– it's not permitted to hand out the material
	Repair according to instruction		Mark the material		Static damage– it's not permitted to hand out the material
	Fix part cold—Afterwards check weld seams and bordering components		Replace damaged material		
	Repair after local economic efficiency calculation		Replace missing material		
	Clean the material				